

1	L93-1051	2250	551	4/8
2	L93-1052	2250	580	4/8
3	L93-1053	2249	535	2/8
4	L93-3055	827	480	3/8
5	L93-3056	979	480	5/8
6	L93-7351	800	1364	7/8_8/8
7	L93-7352	568	1364	7/8_8/8
8	L93-7353	568	1364	7/8_8/8
9	L93-7354	264	1364	7/8_8/8
10	L93-9301	2178	837	4/8
11	L93-9302	2178	987	2/8
12	L93-Z051	827	535	5/8
13	L93-Z052	979	535	5/8
14	L93-Z053	827	535	1/8
15	L93-Z054	979	535	1/8
16	dr-821x30	821	30	5/8
17	dr-975	975	30	5/8
18	w123\1	2668	51	6/8
19	w136\2	2200	16	6/8
20	w136\3	2200	37	6/8
21	w149\2L	2200	50	6/8
22	w149\2P	2200	50	6/8
23	w175\2	2668	32	6/8

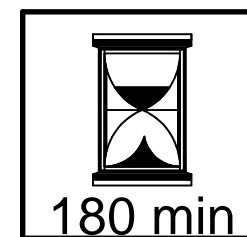

A 55-183--

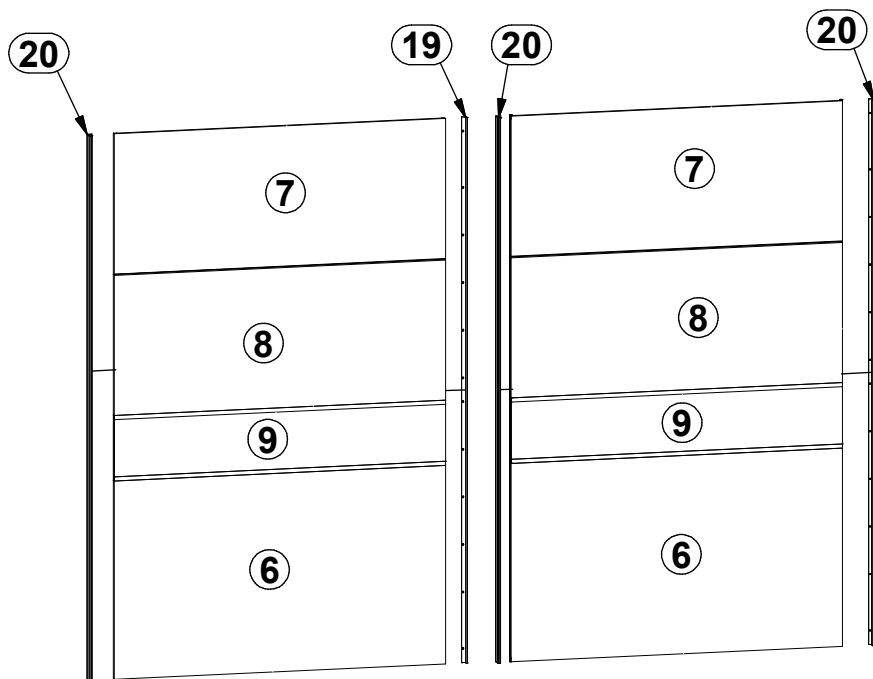

B LED 55-182--

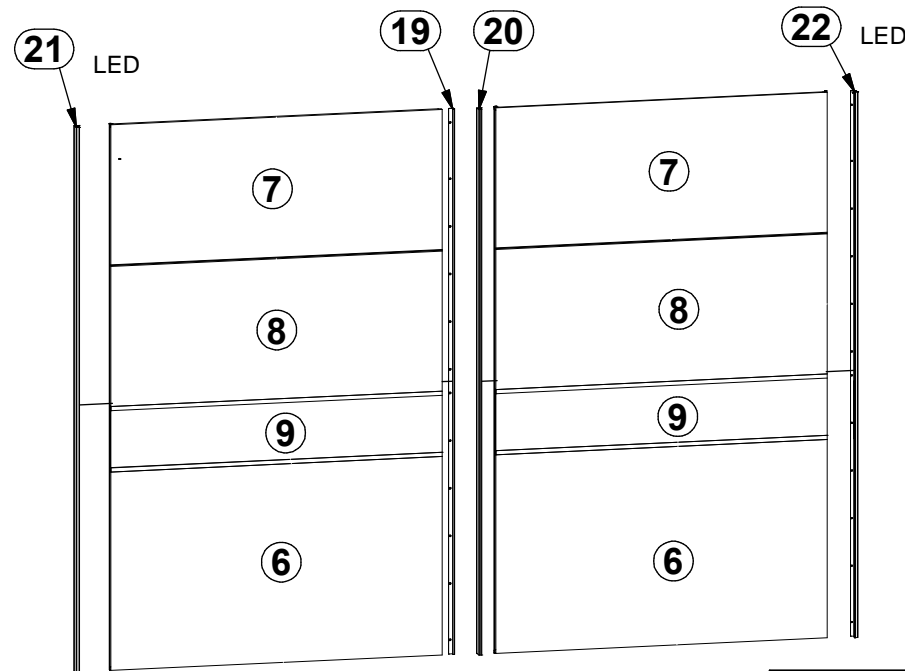

8x l63	1x z1	6x n218	3x w180v1	18x d20	24x d28	28x e5	18x e50	24x e51	8x f6	2x f20	2x f35	2x f55	2x j148	2x j149	14x k1	2x n14v2								
2x n45	2x n46v3	1x n139	18x n148	6x n158	2x n188	1x n189	4x p38	124x p140	36x r37	6x p3	3x s41	12x s1	8x f1	10x j84	10x j140	10x j106	13x p25	4x p16	4x s59	3x k75v4	6x p1	2x p17	1x sp-2200-12	2x sp-2200-4
													4x p125	1x o98v2	6x o83v4									
1x o95v5	1x o95v6	2x o97v1	2x o97v2																					



1

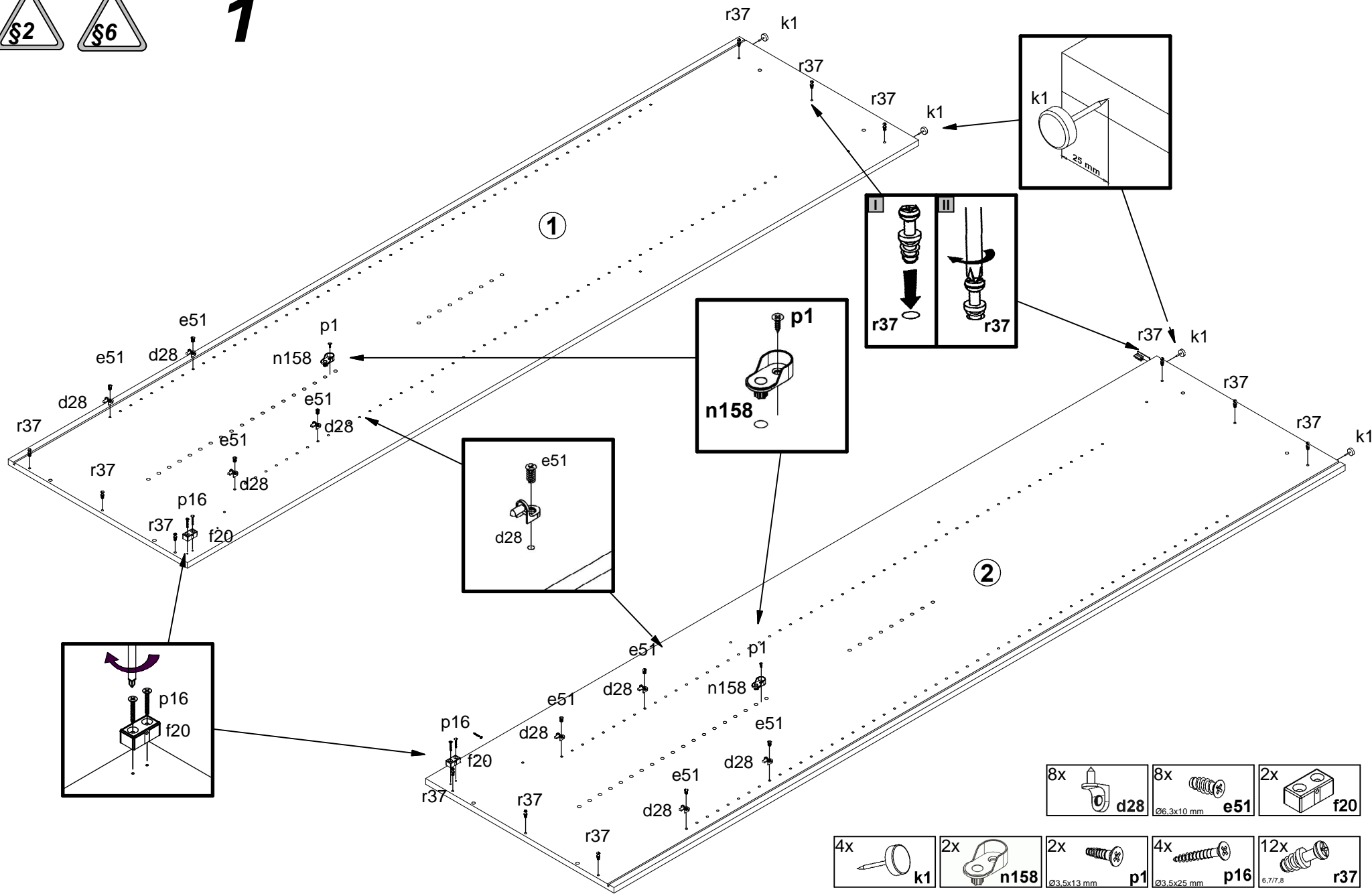

8x		d28	8x		Ø6,3x10 mm	e51	2x		f20
----	--	-----	----	--	------------	-----	----	--	-----

4x		k1	2x		n158	2x		Ø3,5x13 mm	p1	4x		Ø3,5x25 mm	p16	12x		6,7/7,8	r37
----	--	----	----	--	------	----	--	------------	----	----	--	------------	-----	-----	--	---------	-----



2x

2

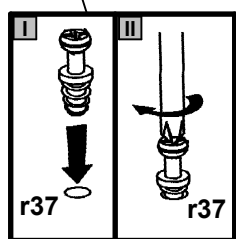
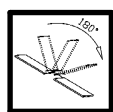
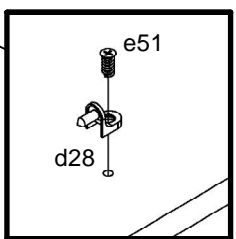
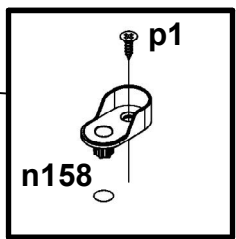
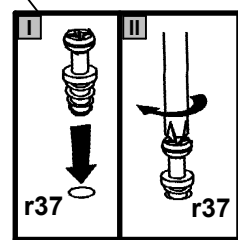
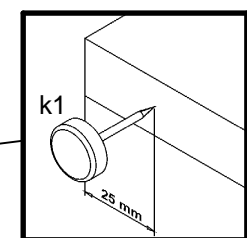
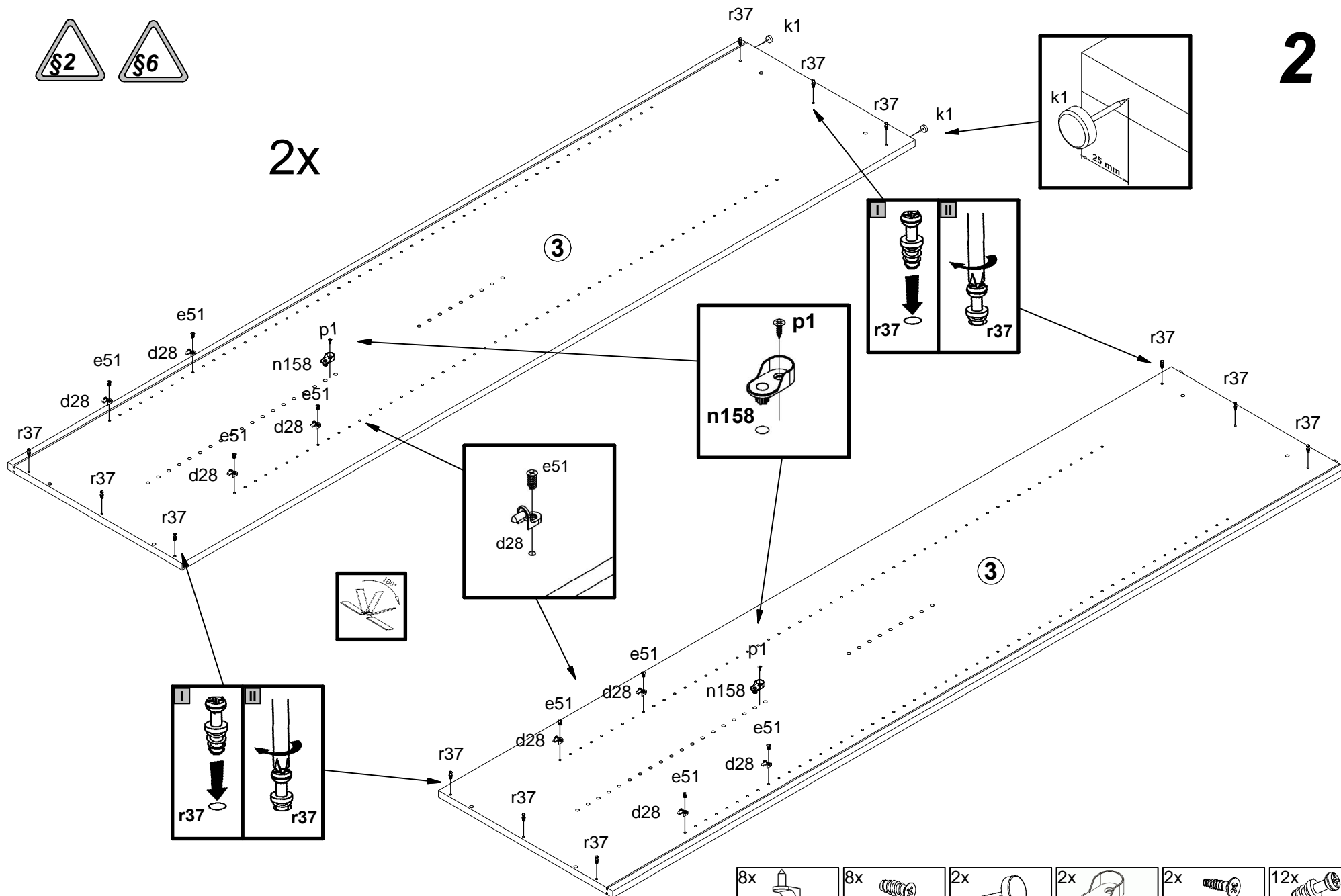

- 8x d28
- 8x e51
- 2x k1
- 2x n158
- 2x p1
- 12x r37

3

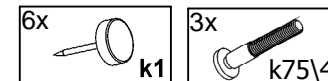
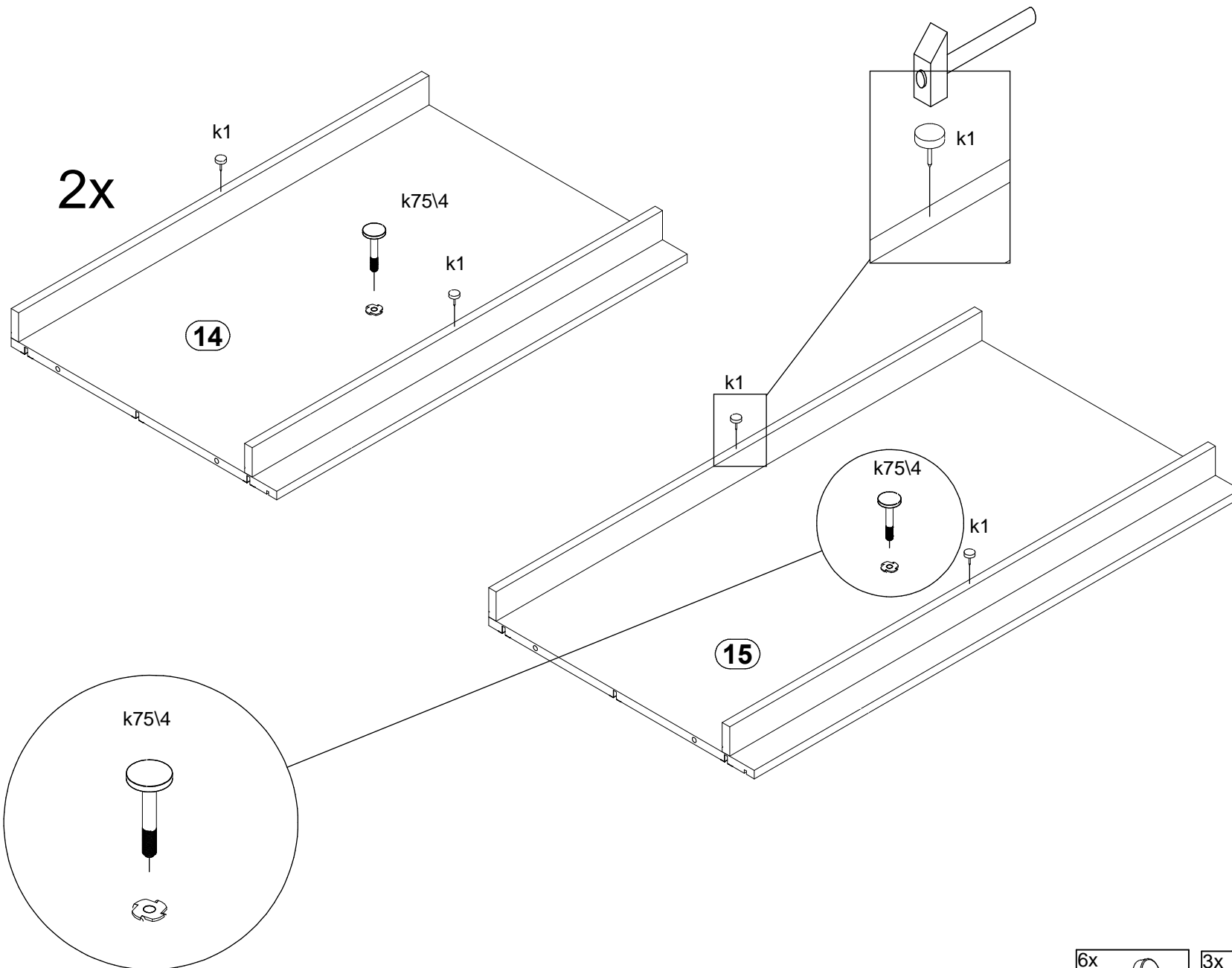

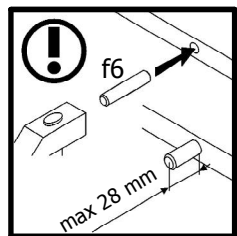

6

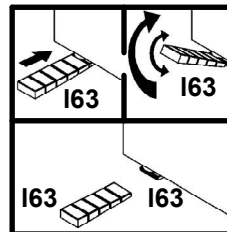

7

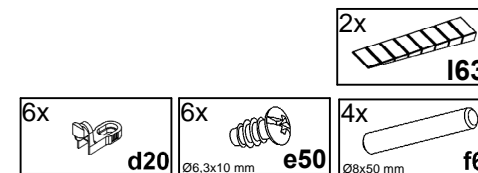
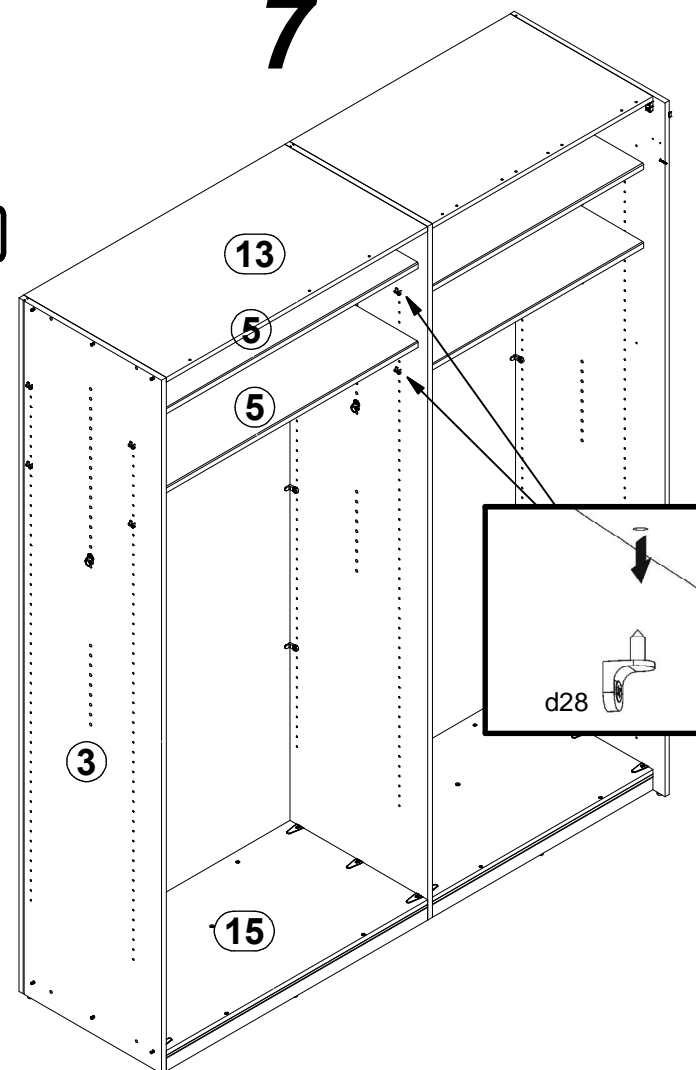
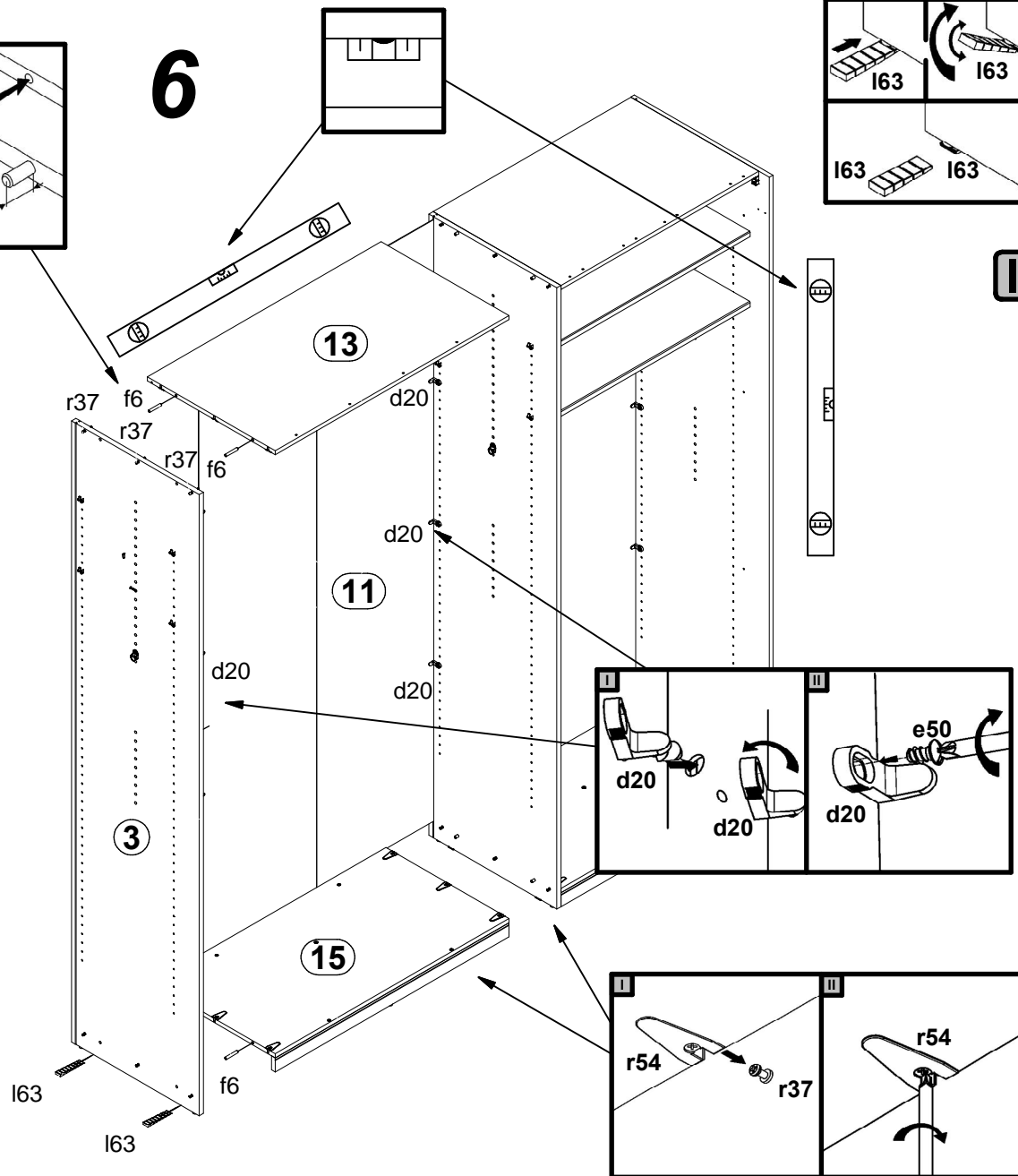

10

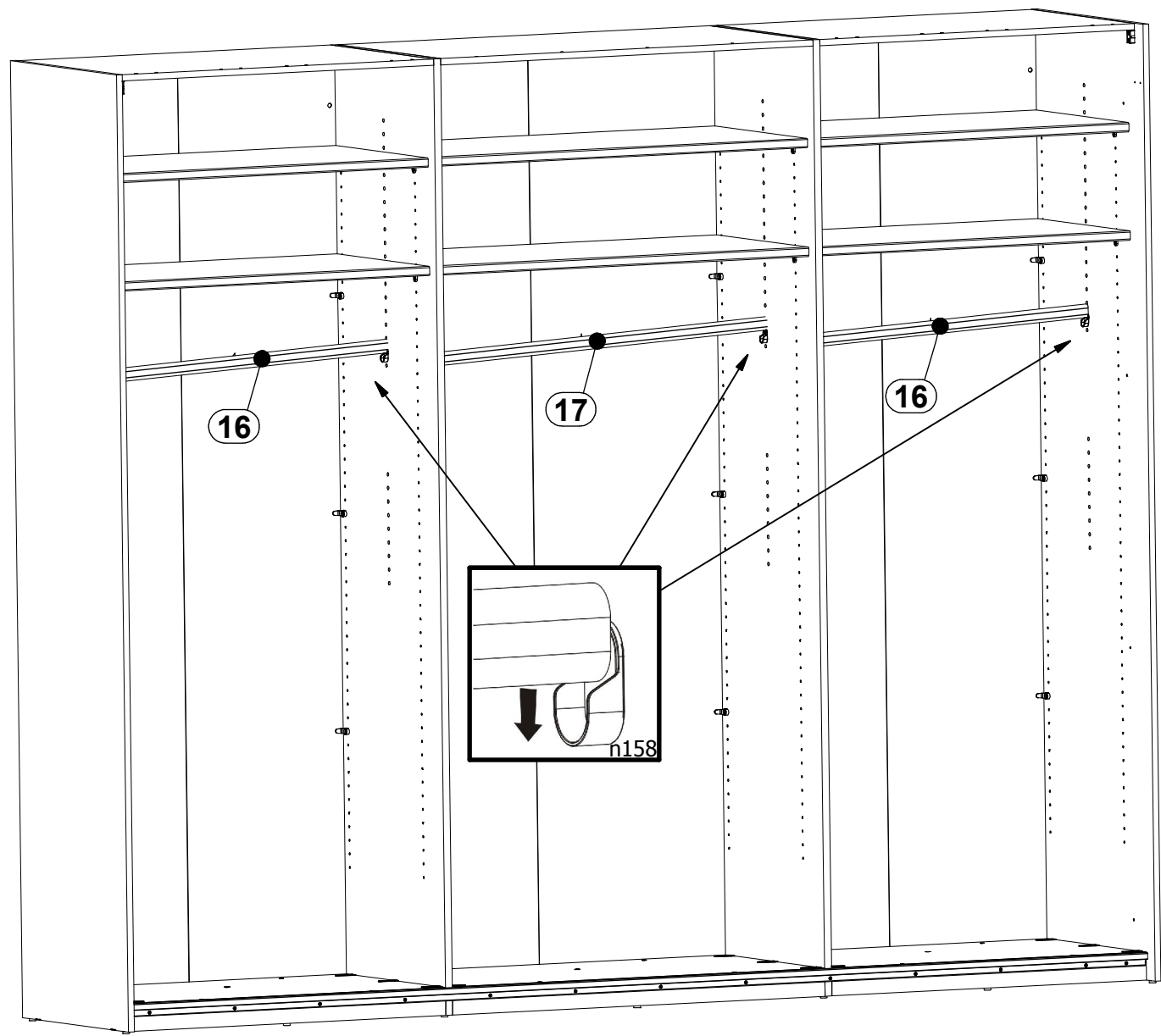

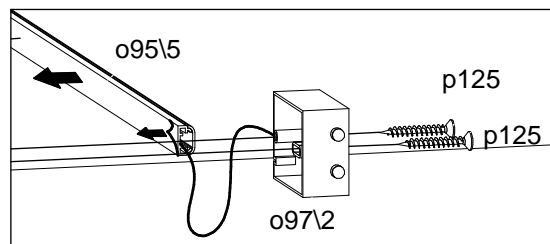

B 55-182-- 11

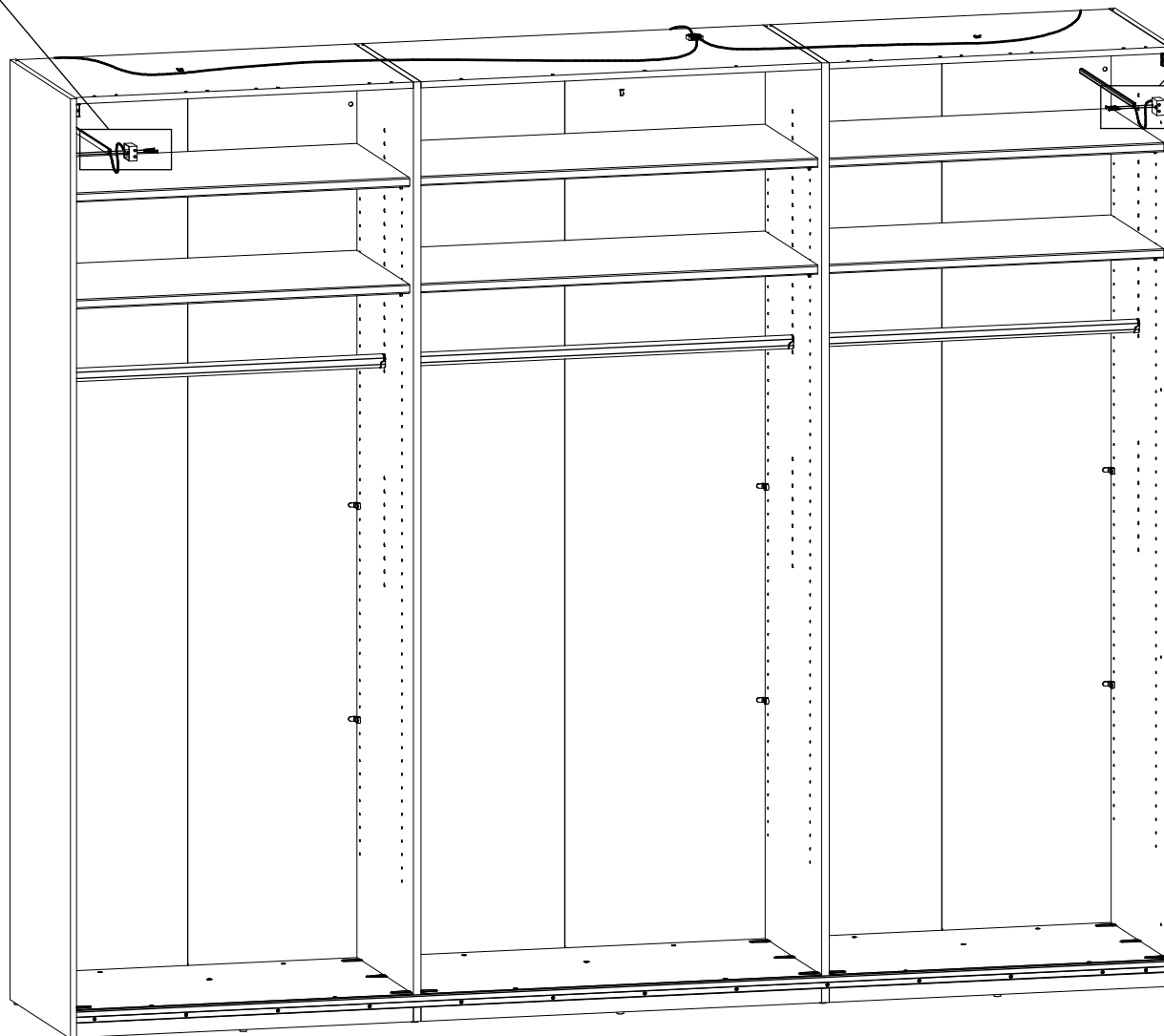
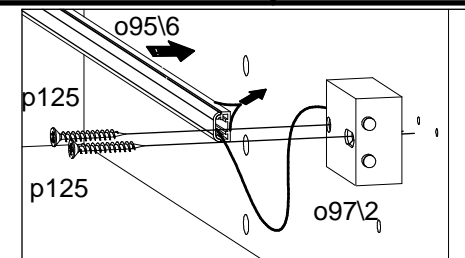

- 2x **o97\2**
- 1x **o98\2**
- 1x **o95\5**
480x7x12
- 1x **o95\6**
500x7x12
- 4x **p125**
∅3x30 mm

- 1x **o98\2**

12

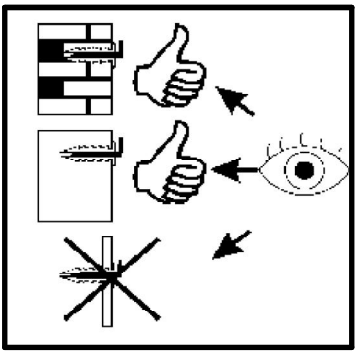
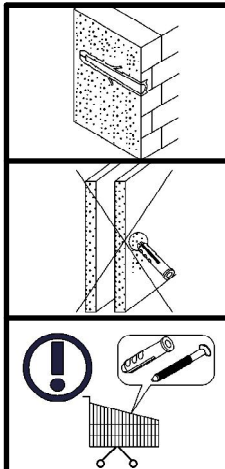
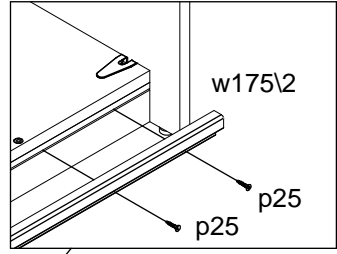
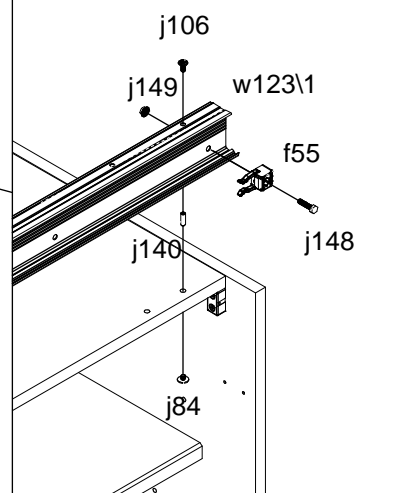
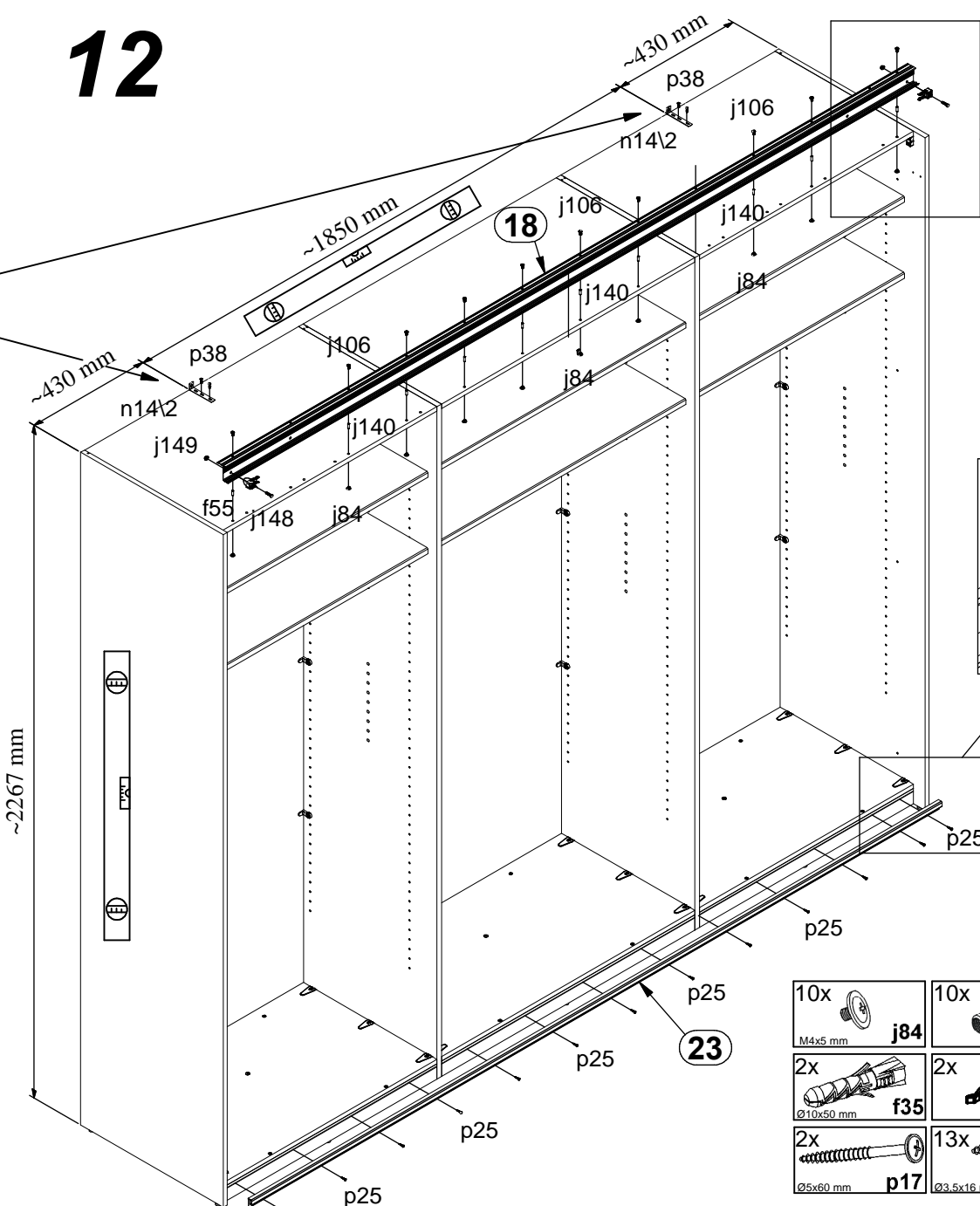
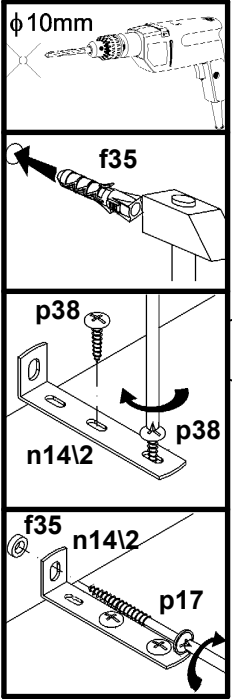

10x M4x5 mm j84	10x j140	10x M4x10 mm j106	
2x Ø10x50 mm f35	2x f55	2x M5x20 mm j148	
2x Ø5x60 mm p17	13x Ø3.5x16 mm p25	4x Ø3.5x16 mm p38	
		2x M5 j149	
			2x 90x21x15\1.5 n14\2

13

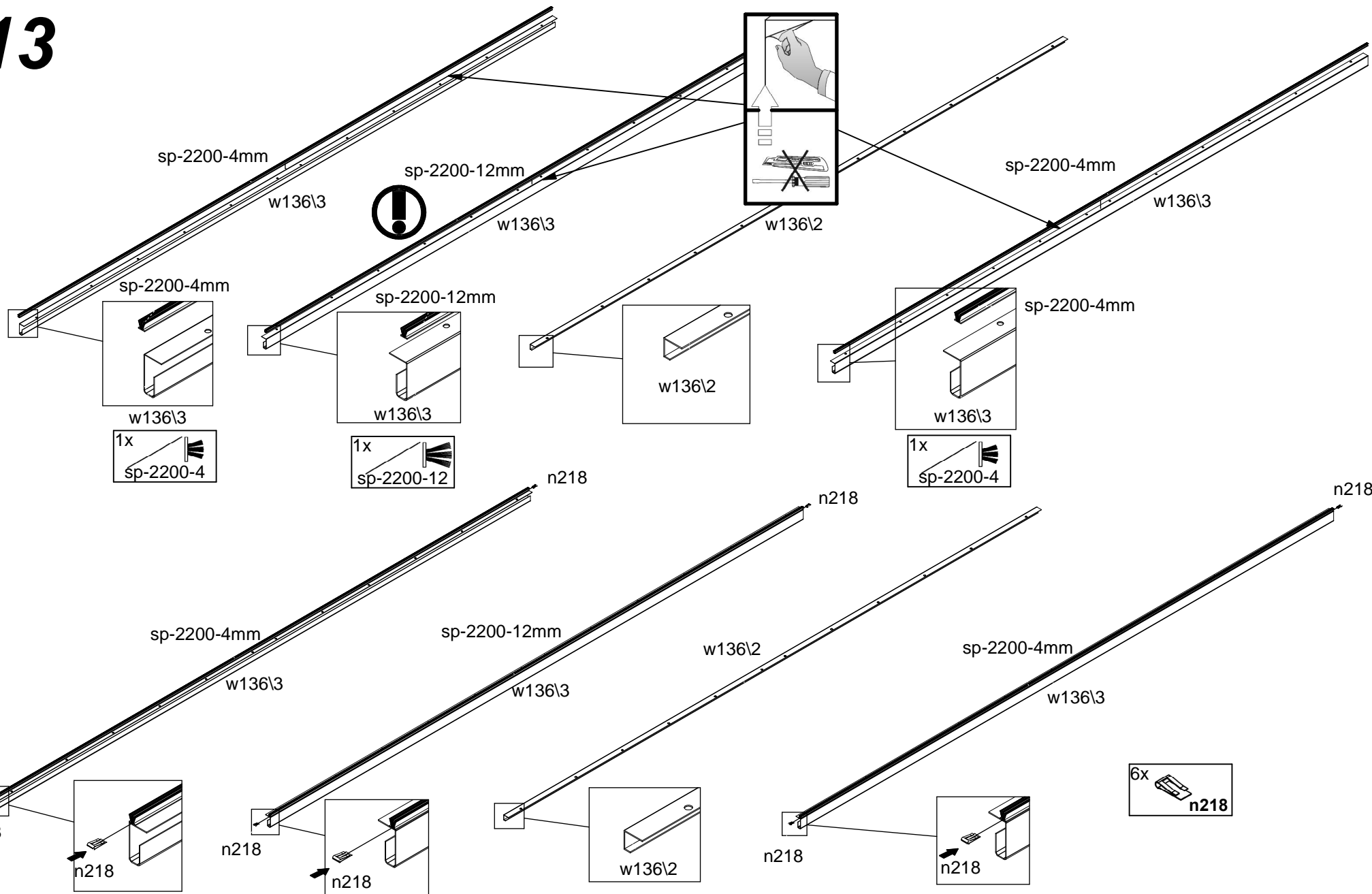
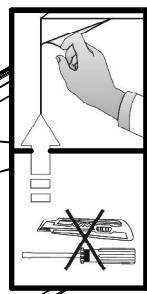

14

15

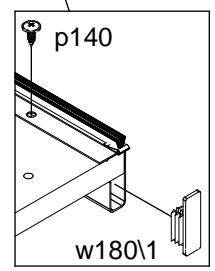
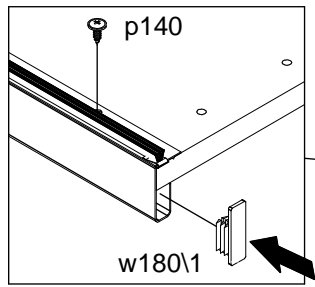
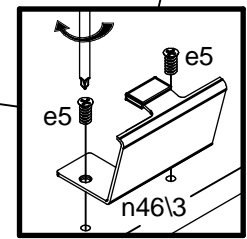
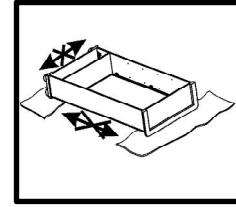
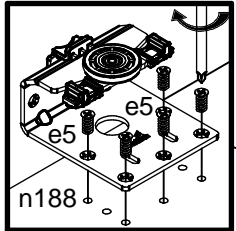
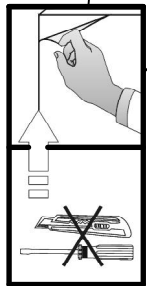
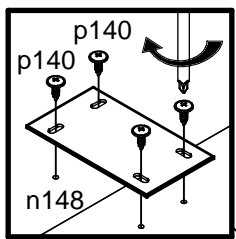
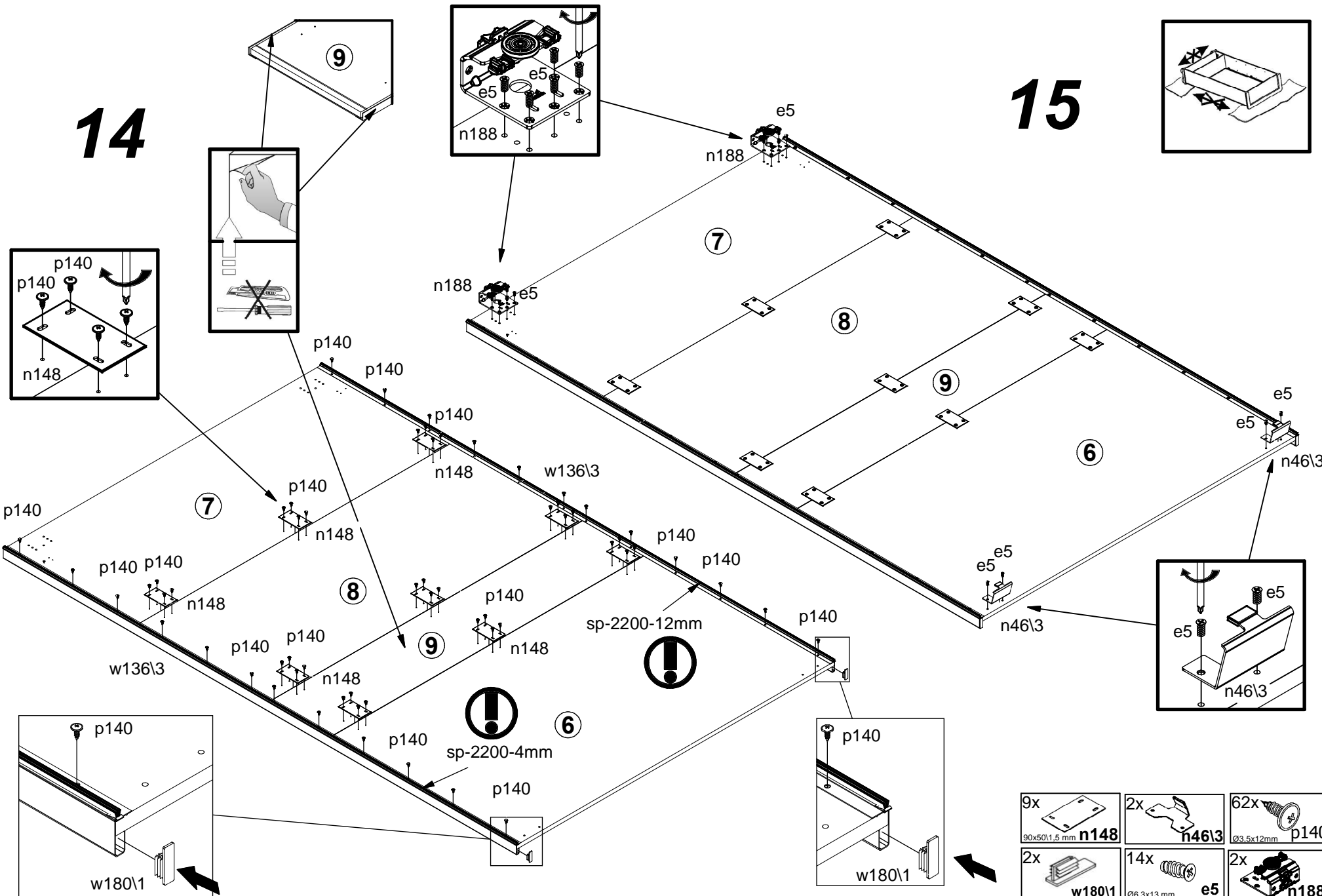

9x 90x50\1,5 mm n148	2x n46\3	62x Ø3,5x12mm p140
2x w180\1	14x Ø6,3x13 mm e5	2x n188

16

17

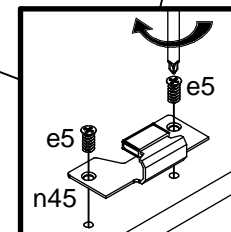
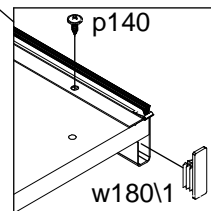
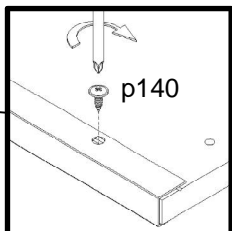
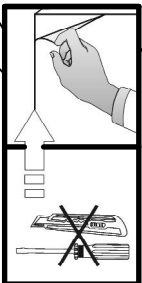
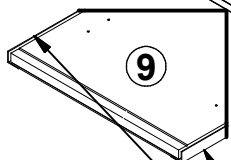
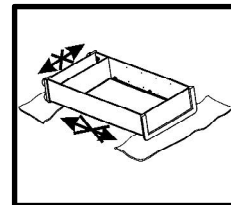
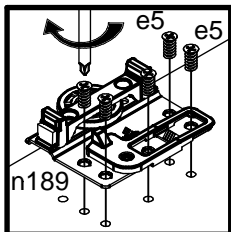
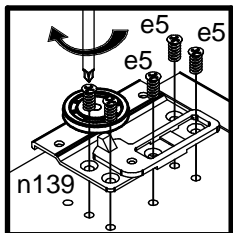
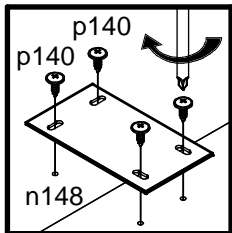
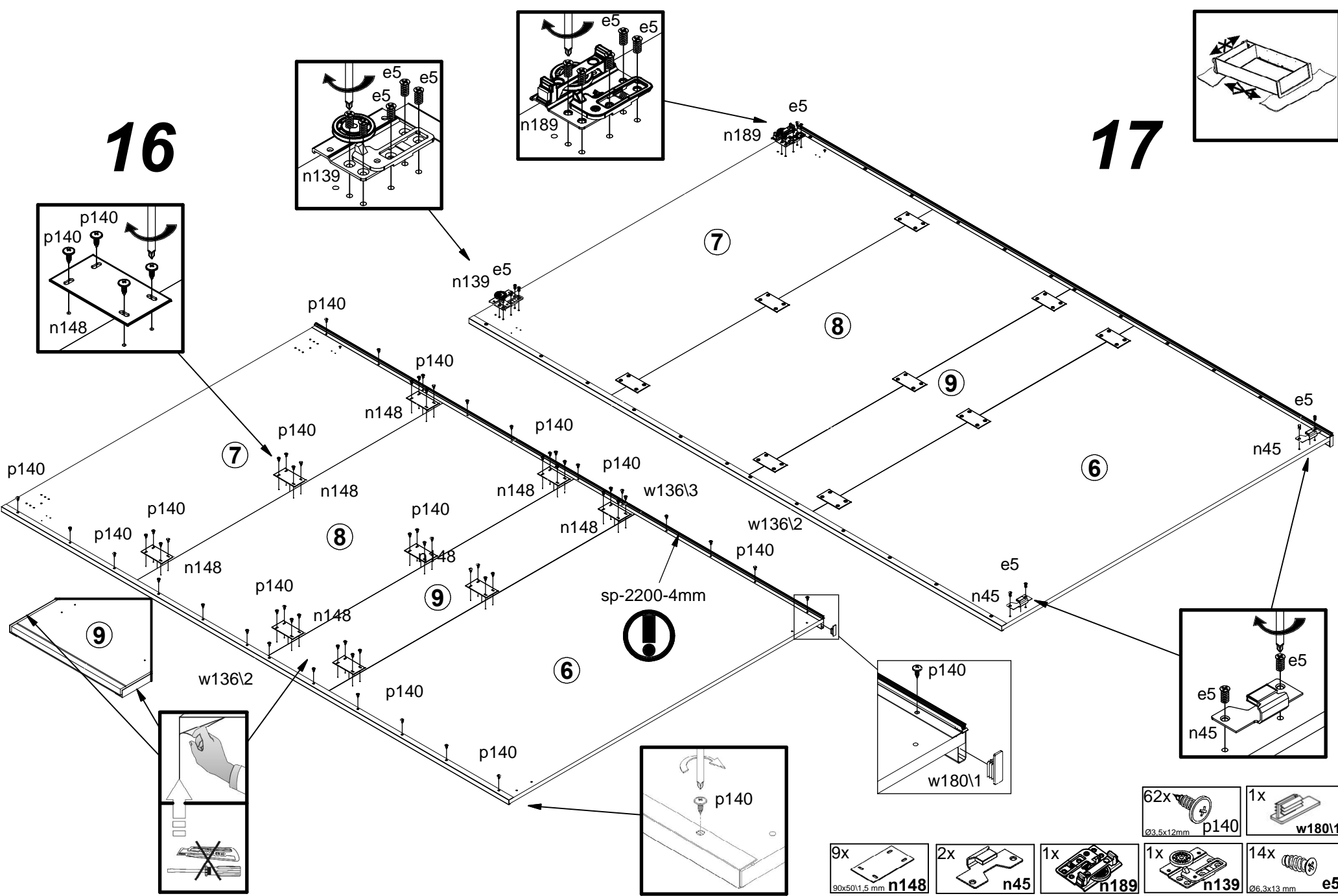

- | | | | | |
|-----------------------------------|------------------|-------------------|---------------------------------|--------------------------------|
| 9x
90x50\1.5 mm
n148 | 2x
n45 | 1x
n189 | 62x
Ø3.5x12mm
p140 | 1x
w180\1 |
| | | | 1x
n139 | 14x
Ø6.3x13 mm
e5 |

B LED 55-182-- 18

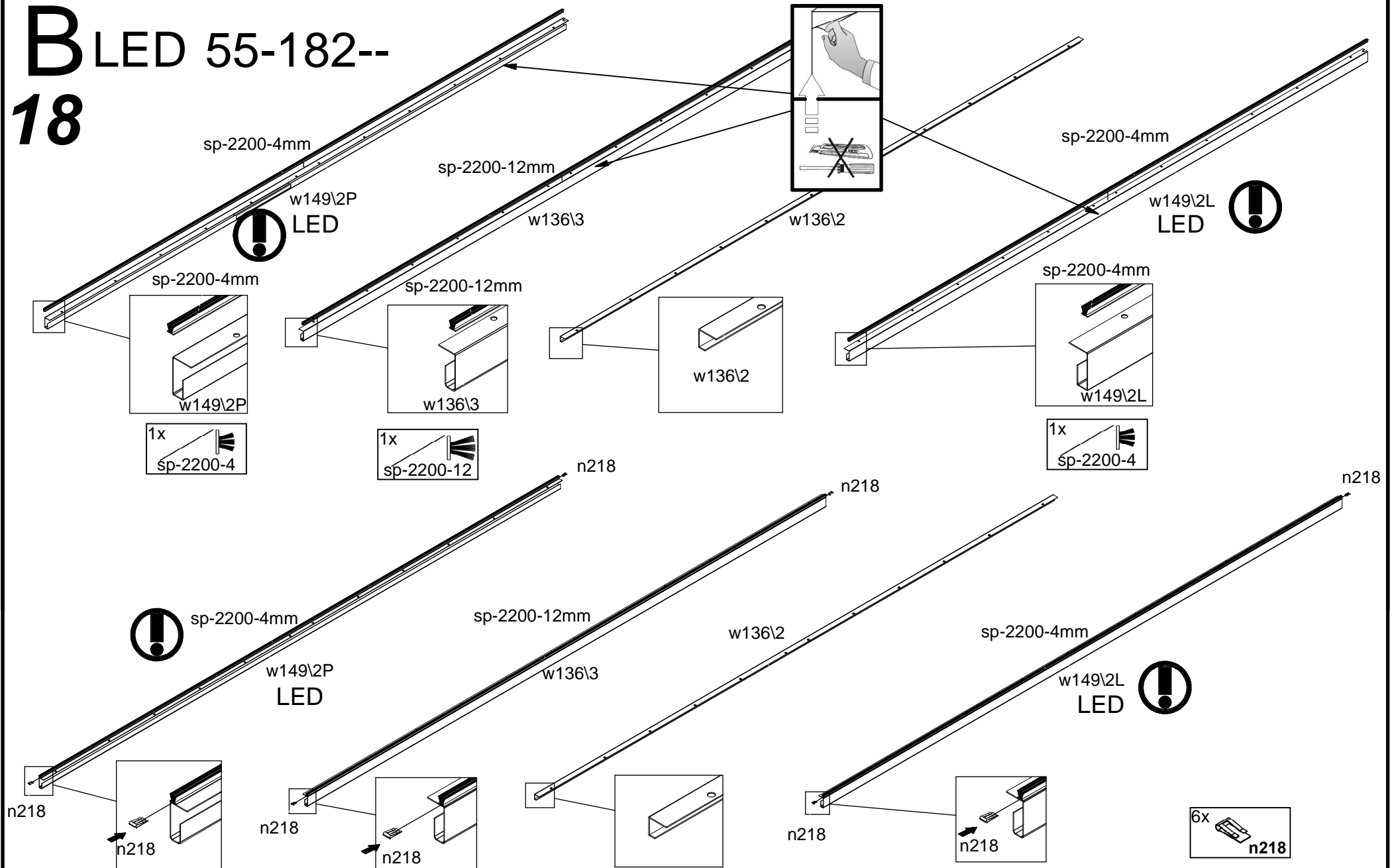

B LED 55-182--

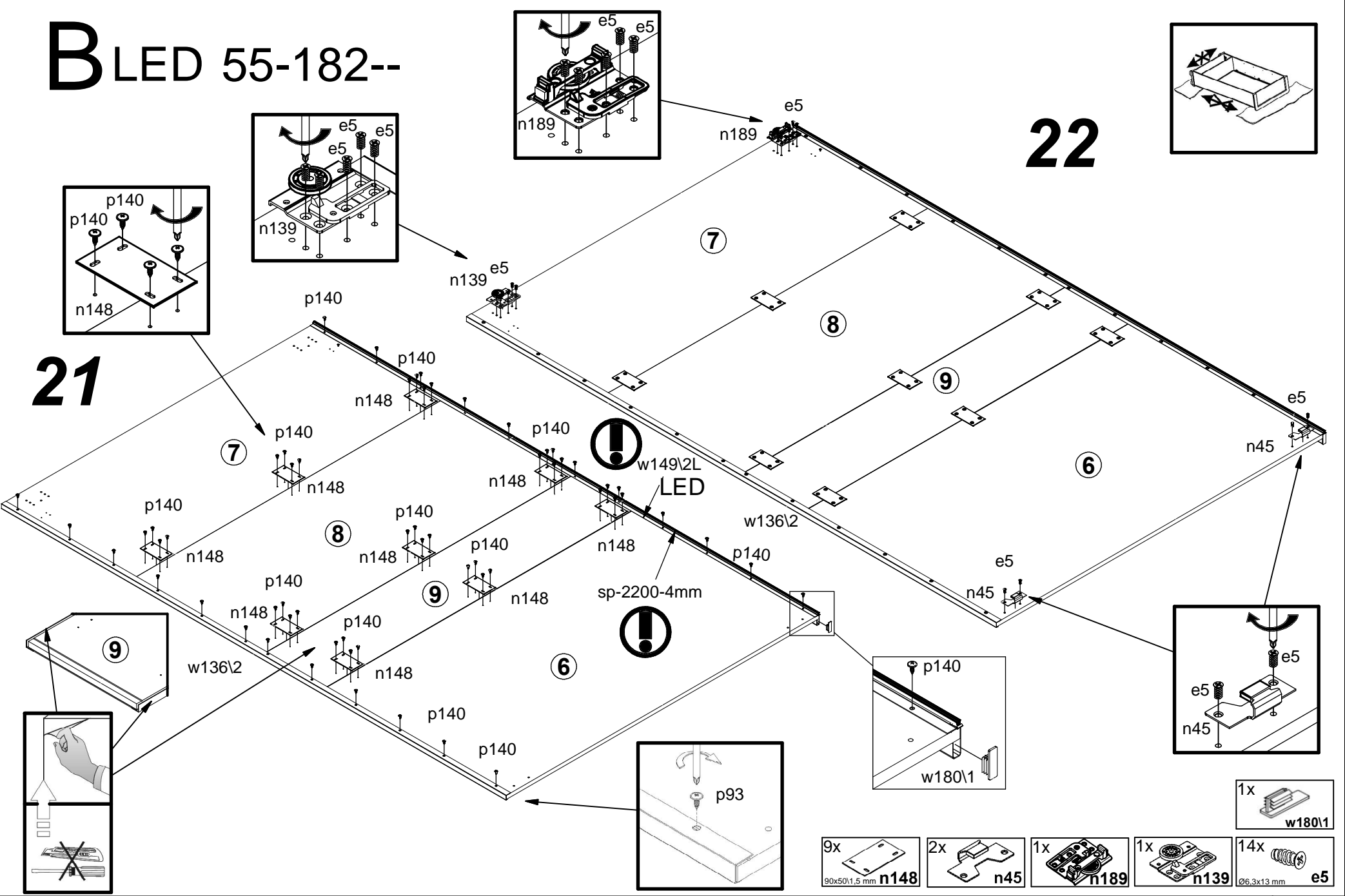

21

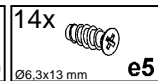
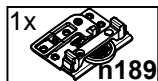
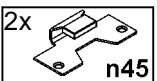
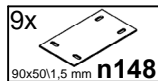
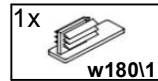
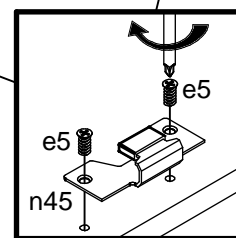
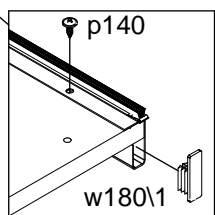
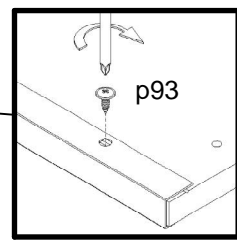
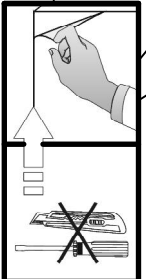
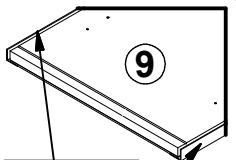
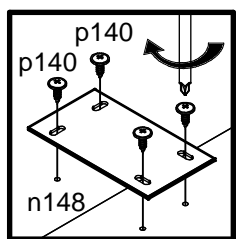
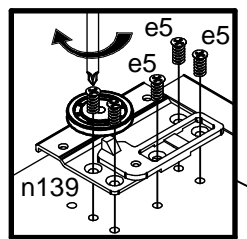
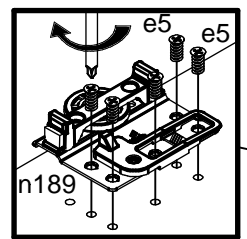
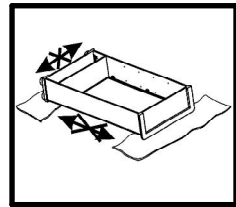

22

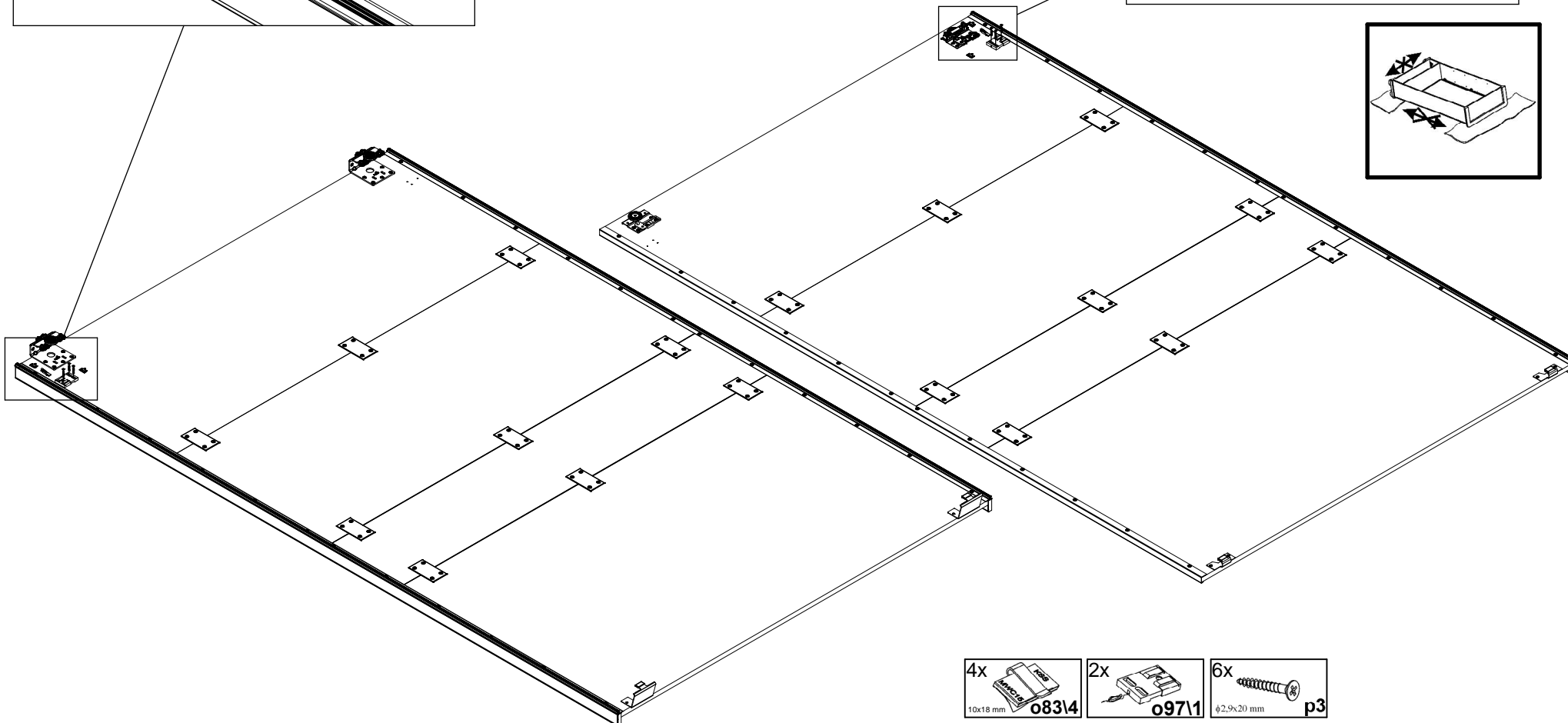
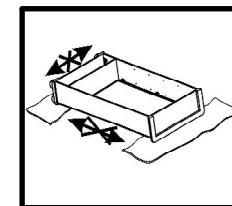
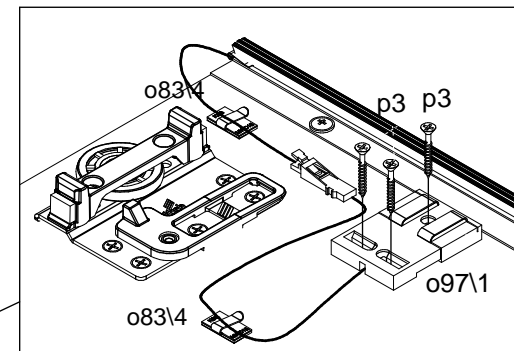
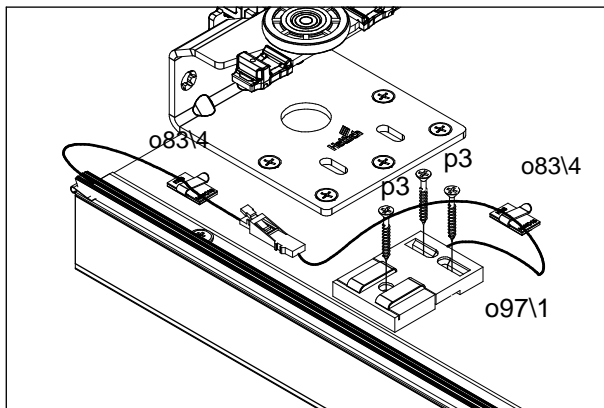

B 23

55-183--

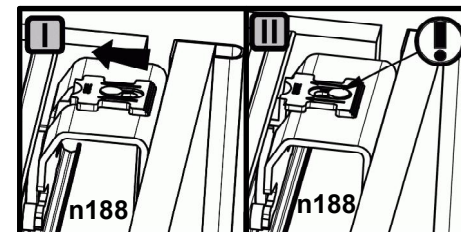
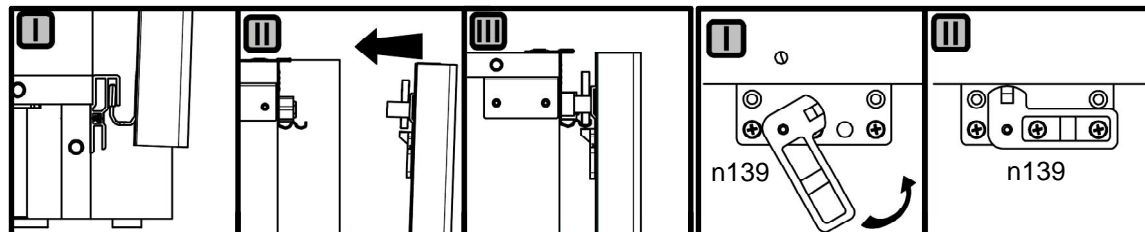

- 4x

10x18 mm **o83\4**
- 2x

o97\1
- 6x

φ2,9x20 mm **p3**

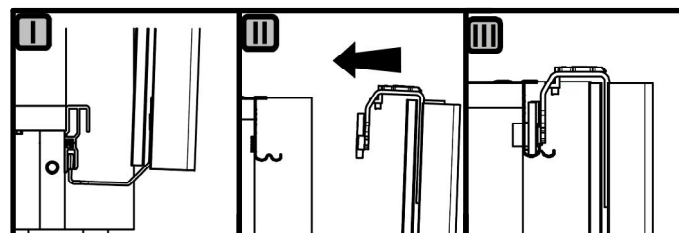
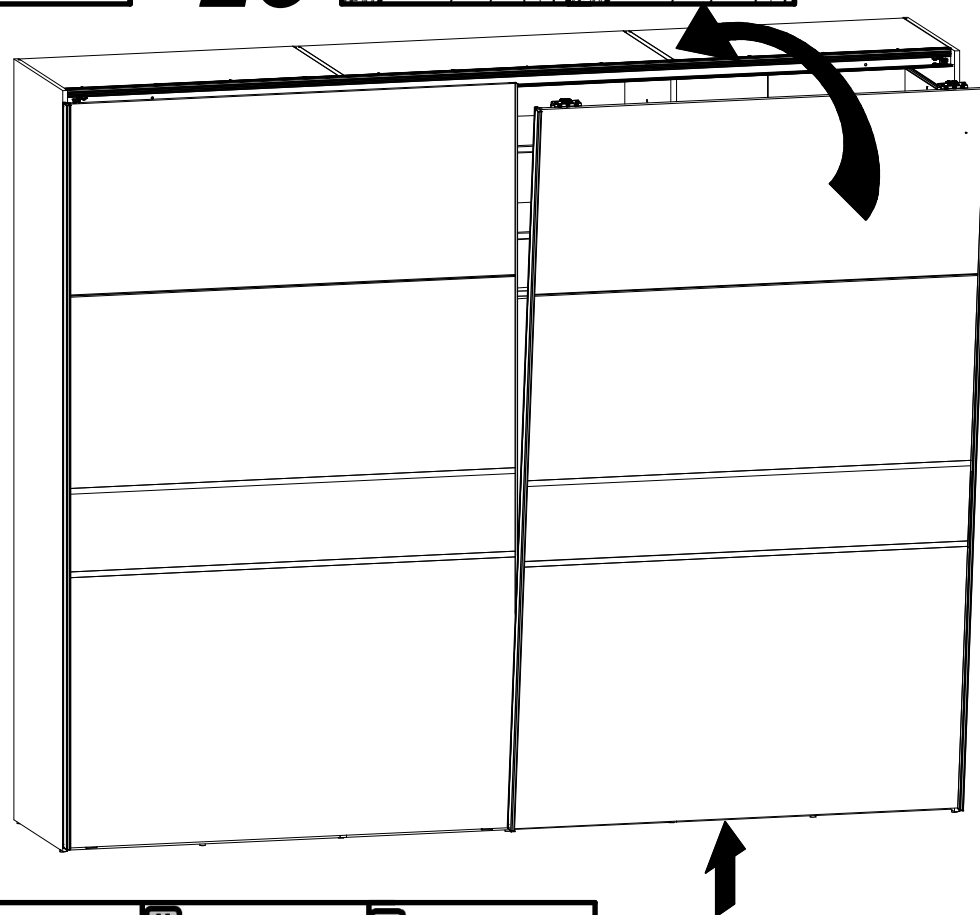
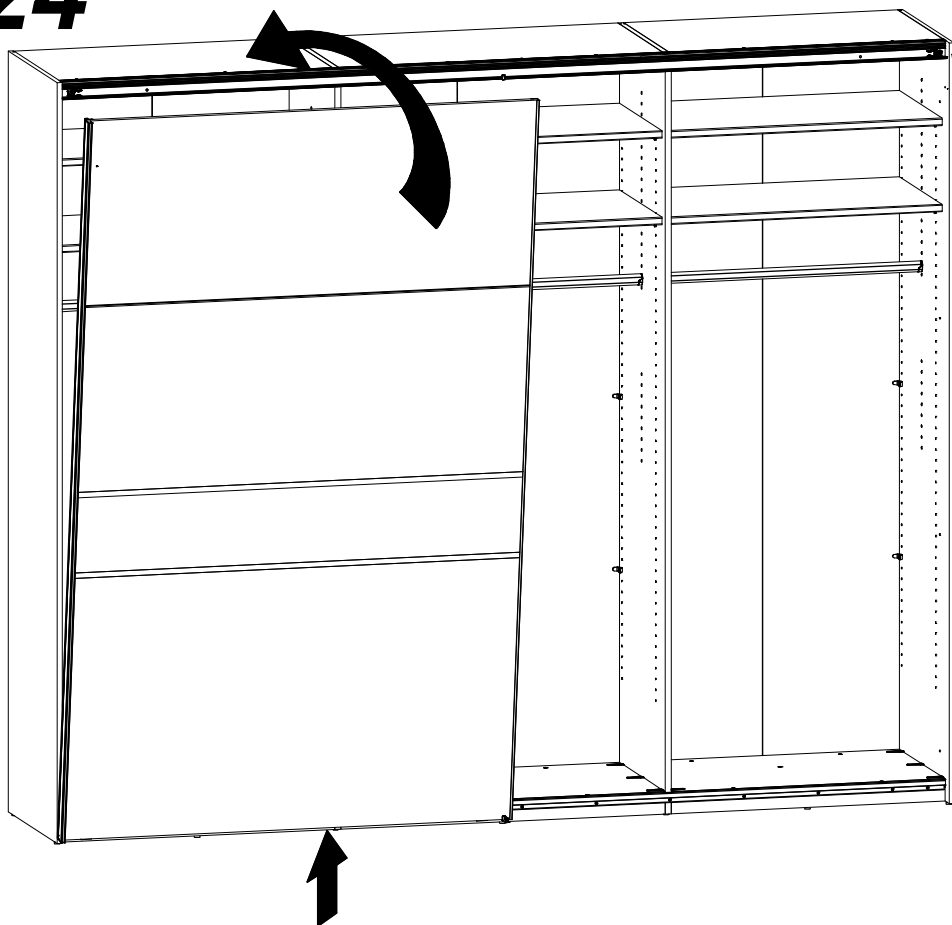

25

24



26

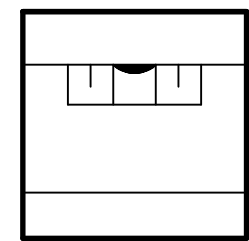
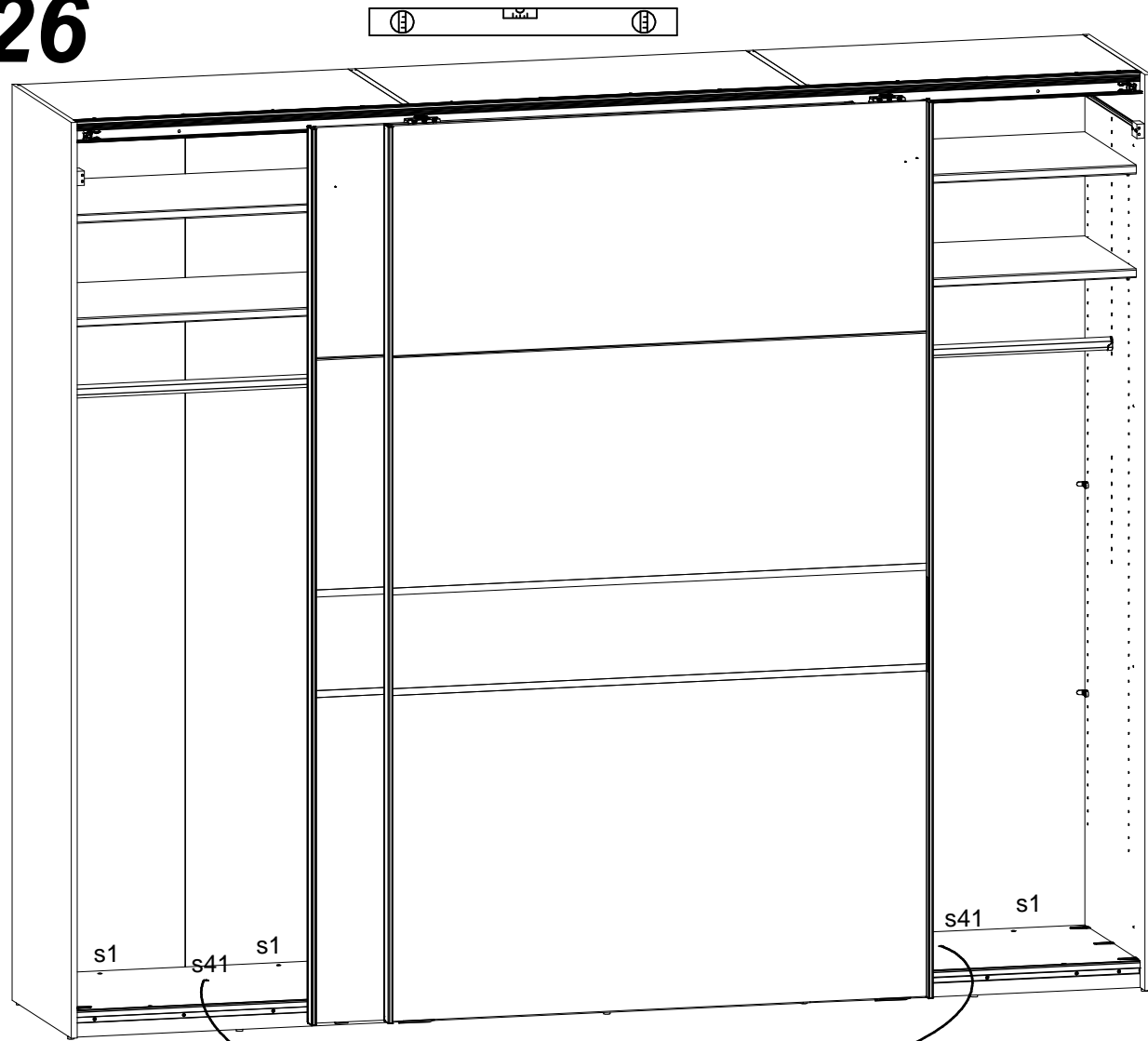

§21

s59

§21

s1

12x

s1

4x

Ø14x0,5 mm s59

k75v4

z1

1x

4 mm z1

3x

Ø12x4 mm s41