

ROOF

30C1--01

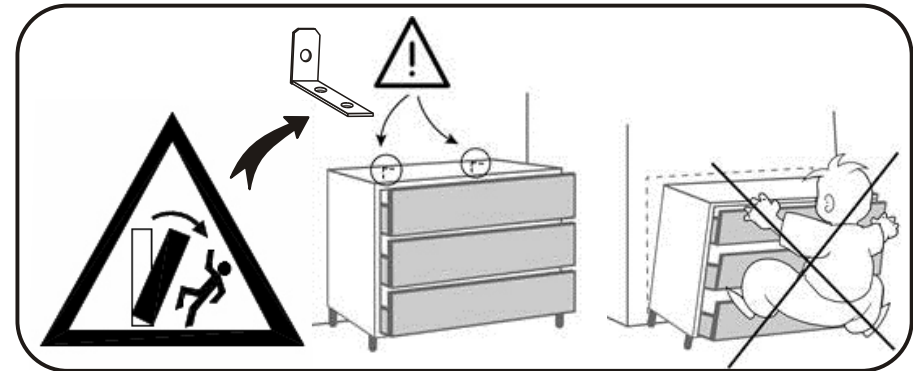

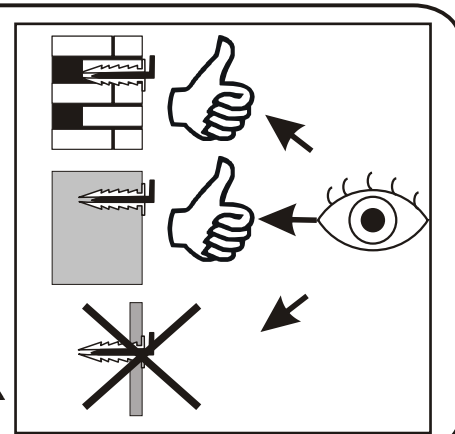
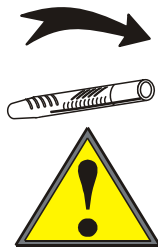
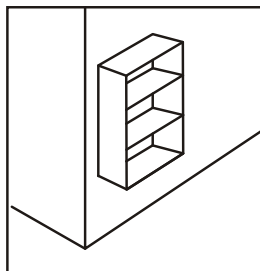
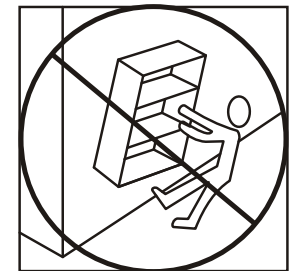
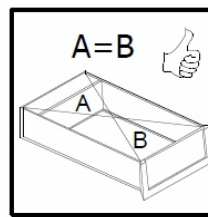
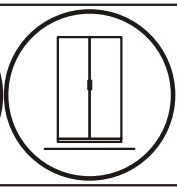
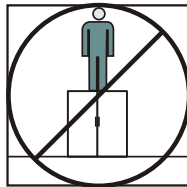
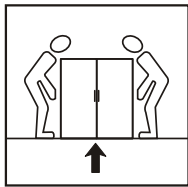
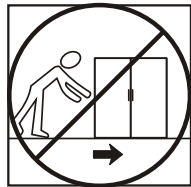
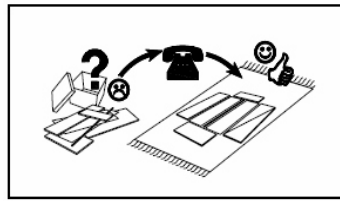
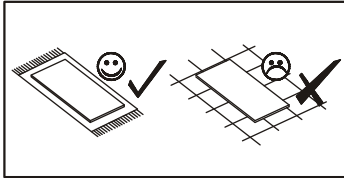
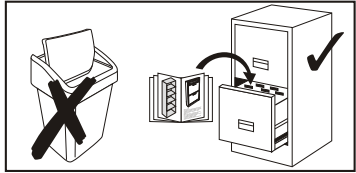
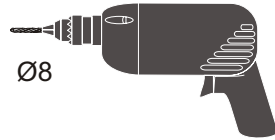
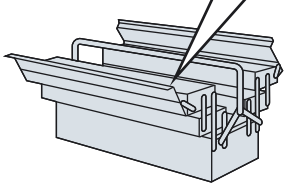
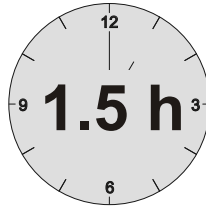
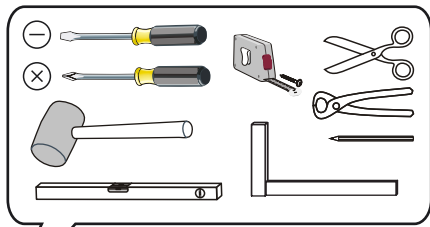
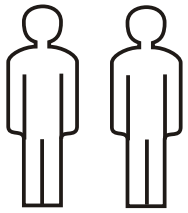
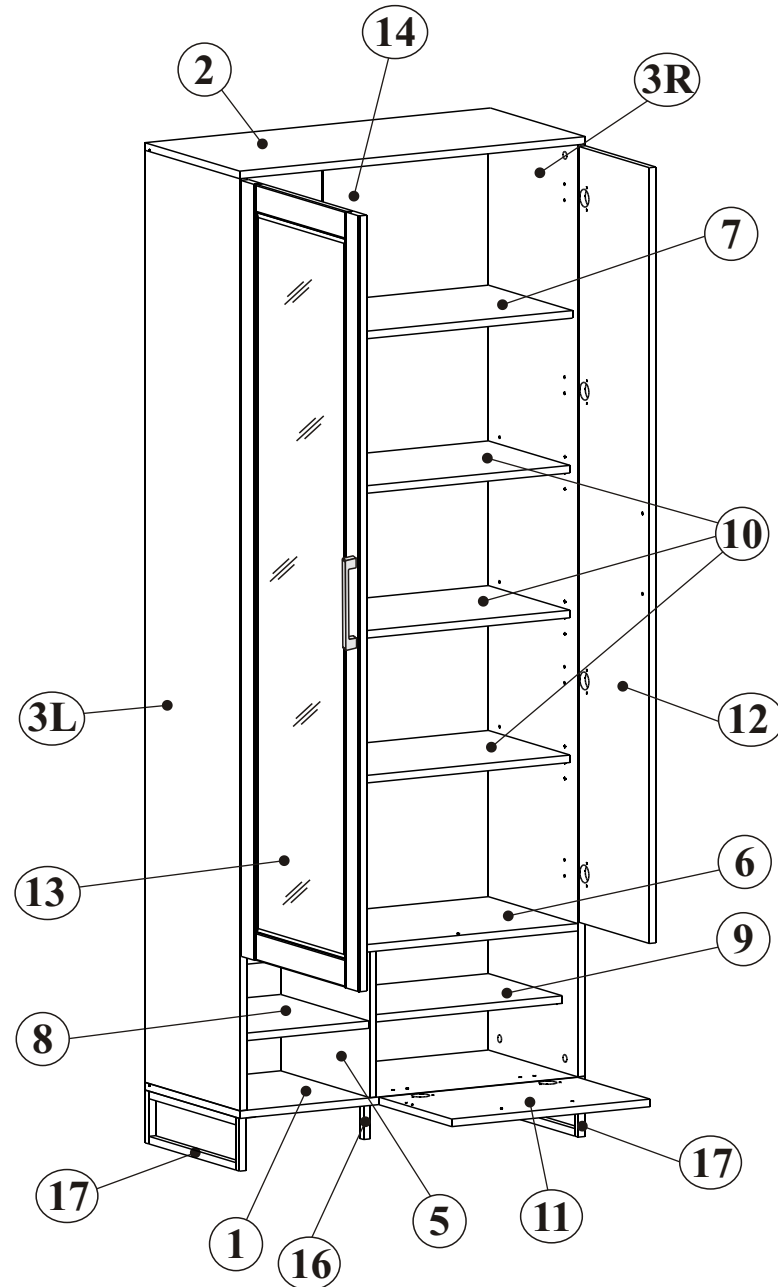
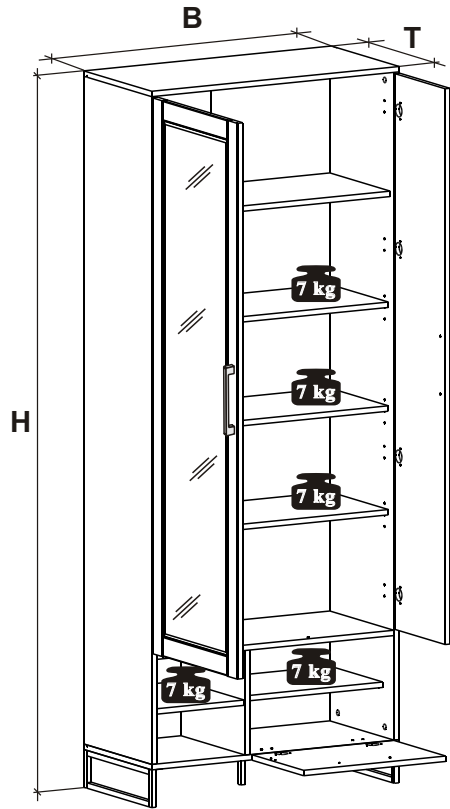

B - 782mm
 H - 1994mm
 T - 372mm



1	782	372	1	1/2
2	782	372	1	1/2
3L,3R	1854	371	2	2/2
5	290	349	1	1/2
6	750	350	1	1/2
7	750	330	1	1/2
8	280	345	1	1/2
9	455	290	1	1/2
10	750	320	3	1/2
11	449	284	1	1/2
12	1543	277	1	2/2
13	1543	464	1	2/2
14	1863	758	1	2/2

NR 1

B1  8x28 x20

M1  15x12mm x20

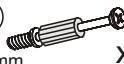
T1  5x39mm x20

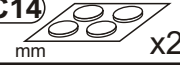
C14  mm x20

NR 2

J23  x18

W1  x21

S6  3x20 x4

W10  x2

S0  2,5x12 x2

NR 3

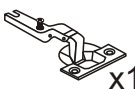
Y1  Kr15 x10

D7  H4 x10

E3  6,3x13 x20

S8  4x13 x20

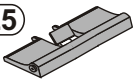
Z5  x2

NR 4

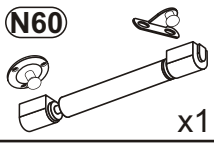
N60  x1

S3  3,5x13 x5

NR 5

U160  x3

A14  M4x22 x6

NR 6

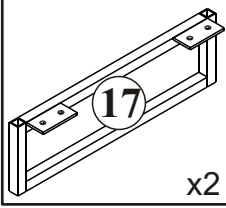
17  x2

16  x1

E18  6,3x16 x12

NR 7

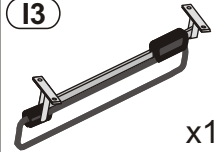
13  x1

S3  3,5x13 mm x4

NR 8

J11  x1

P13  3,5x13 x2

T13  8x50 mm x1

T14  6x50 mm x1

C 1/2



ROOF

30C1--01

1

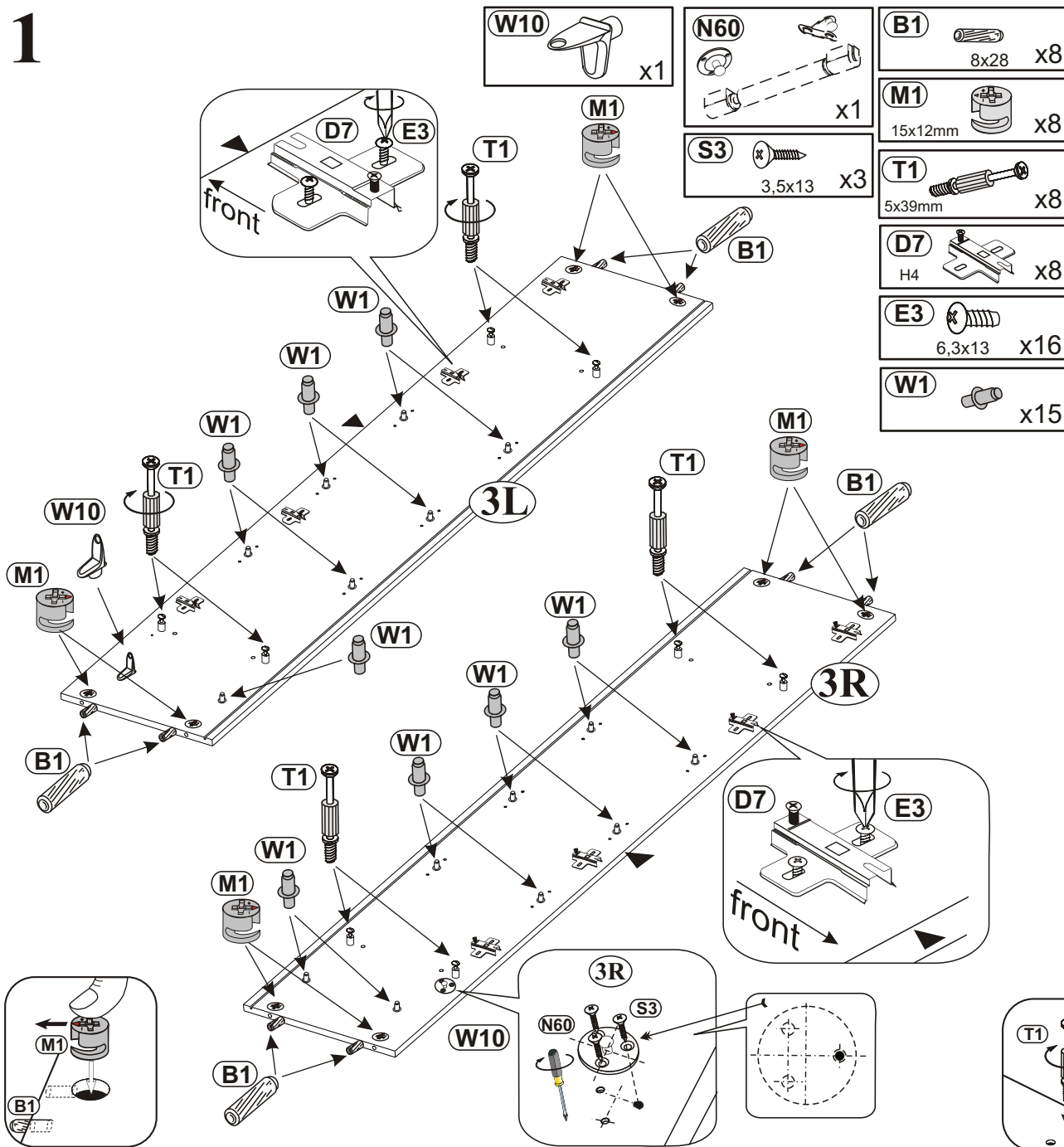

2

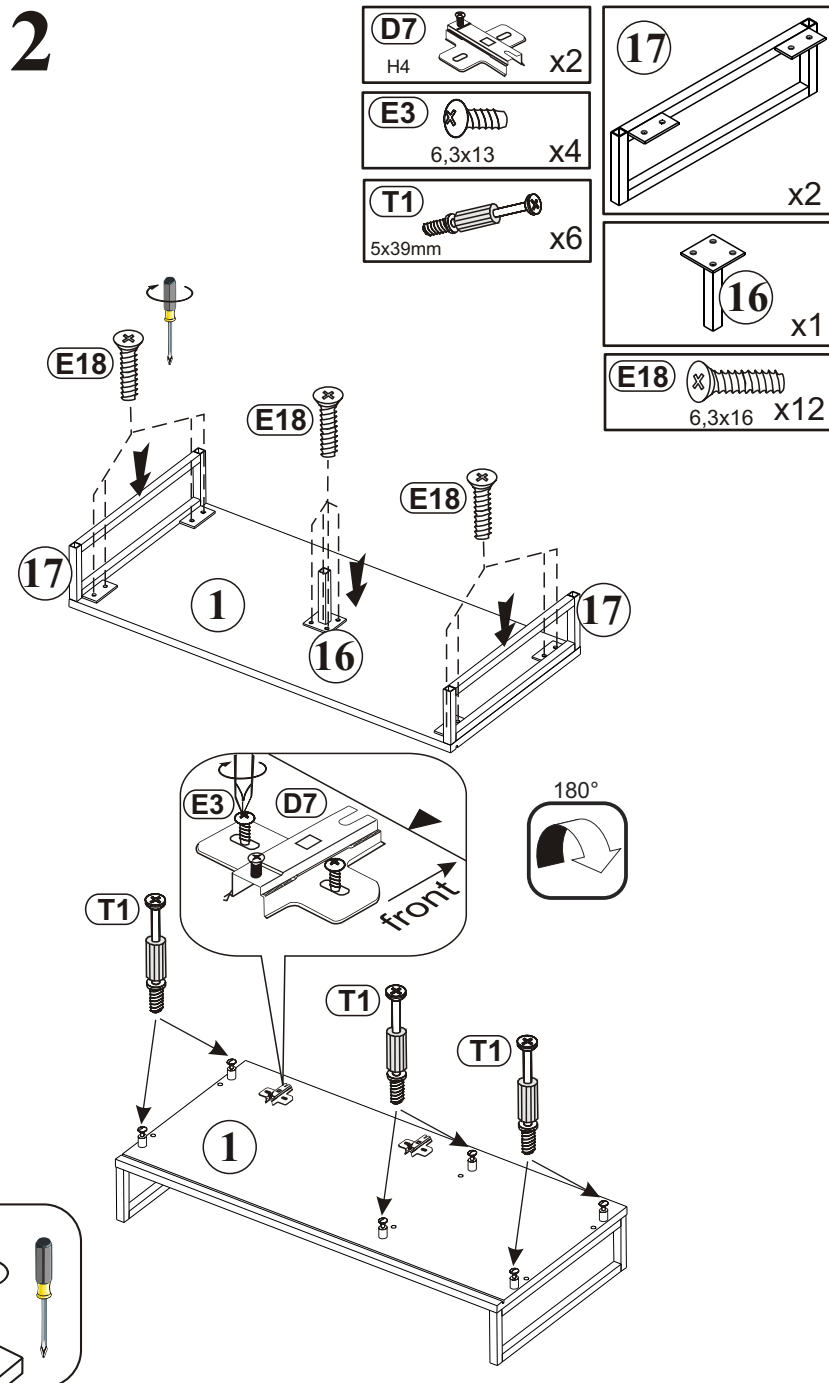

ROOF

30C1--01

3

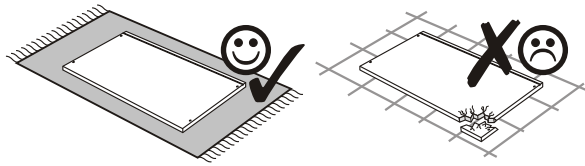

- B1** 8x28 x4
- M1** 15x12mm x4
- T1** 5x39mm x4
- W1** x1
- I3** x1
- S3** 3,5x13 mm x4

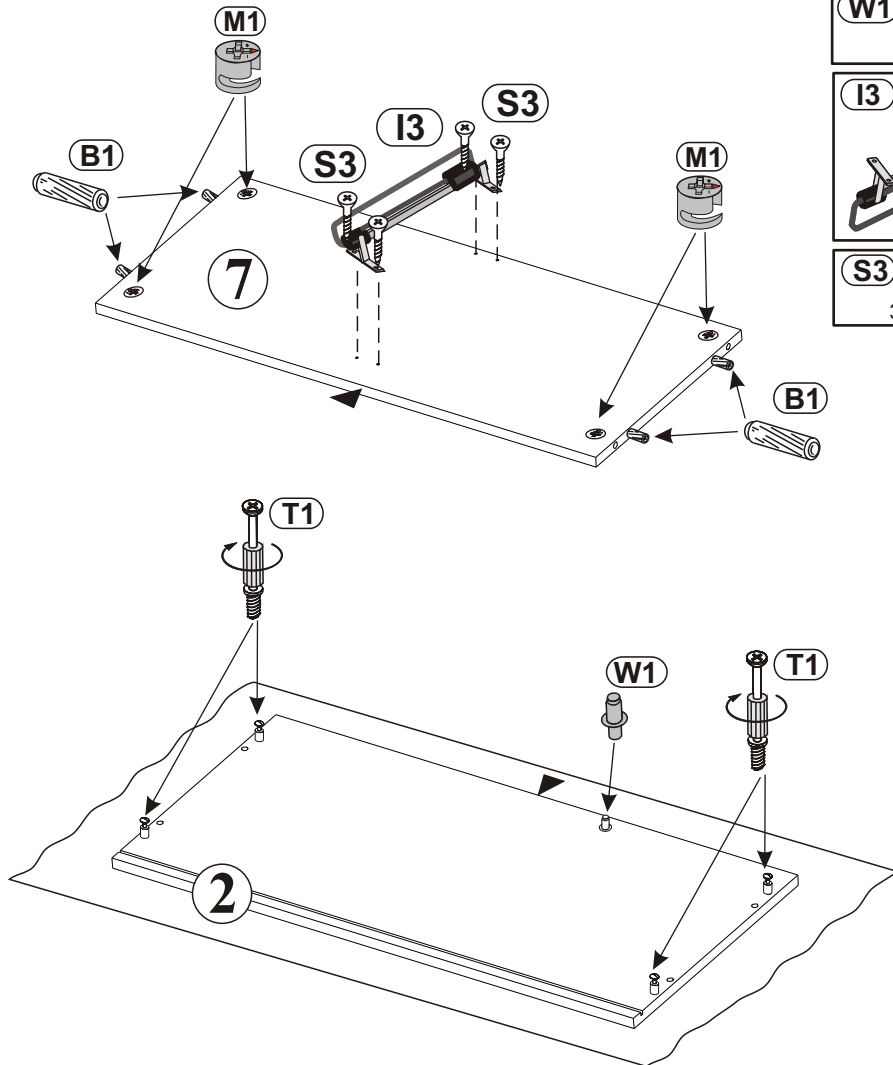

4

- B1** 8x28 x8
- T1** 5x39mm x2
- W1** x5
- M1** 15x12mm x8
- W10** x1

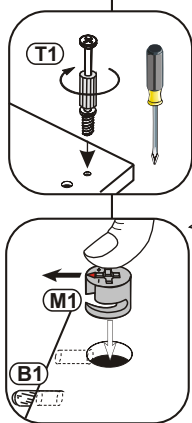
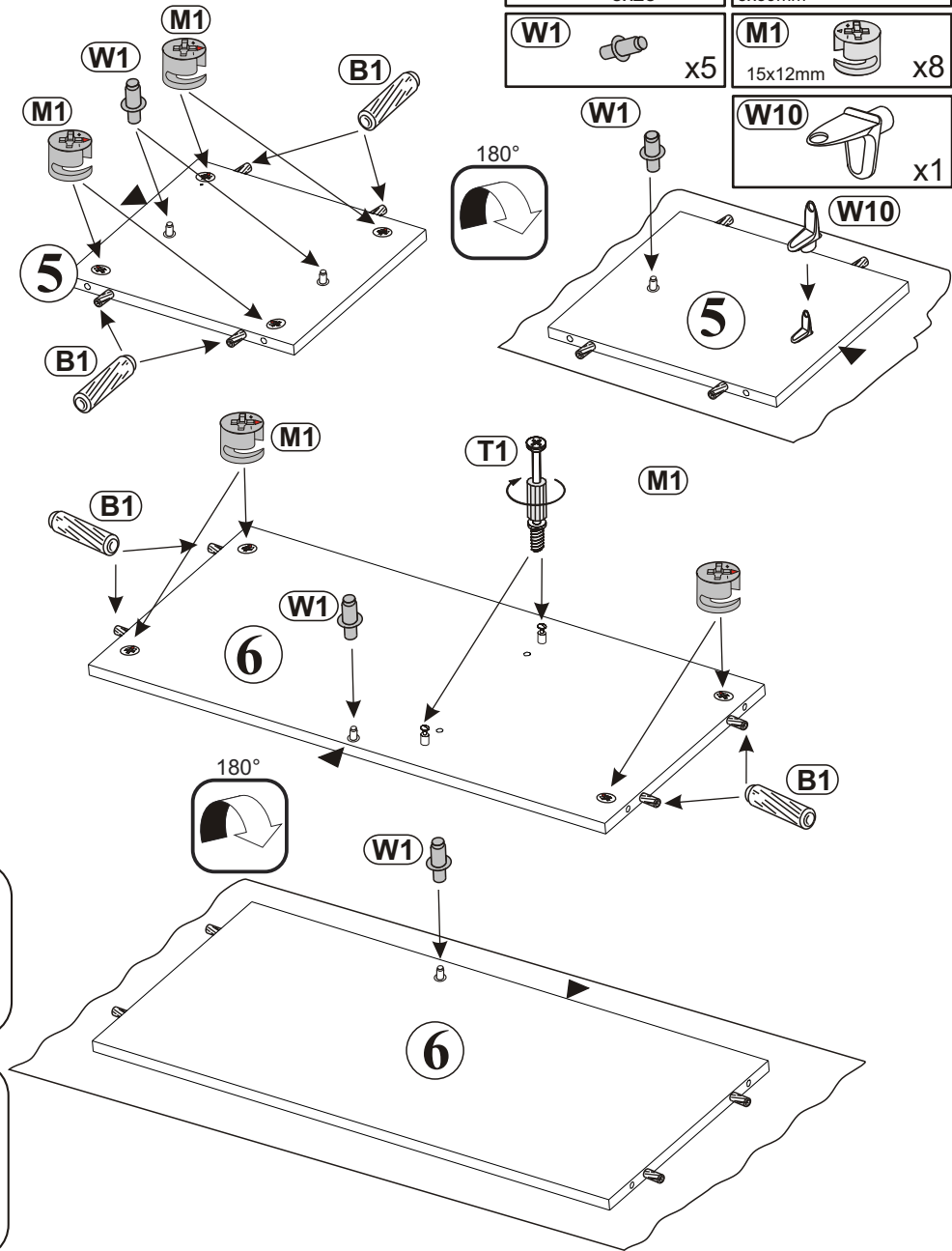

5

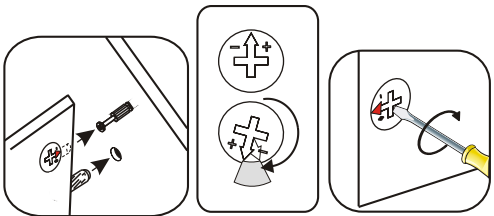
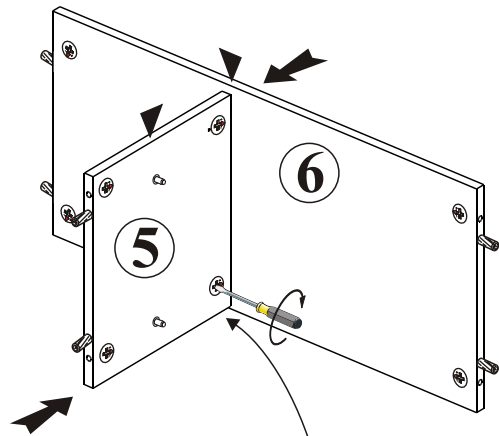

6

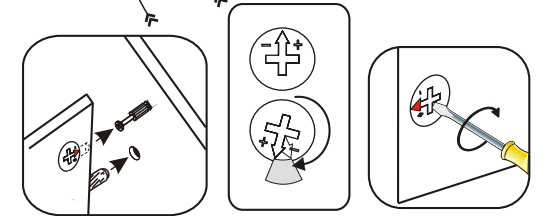
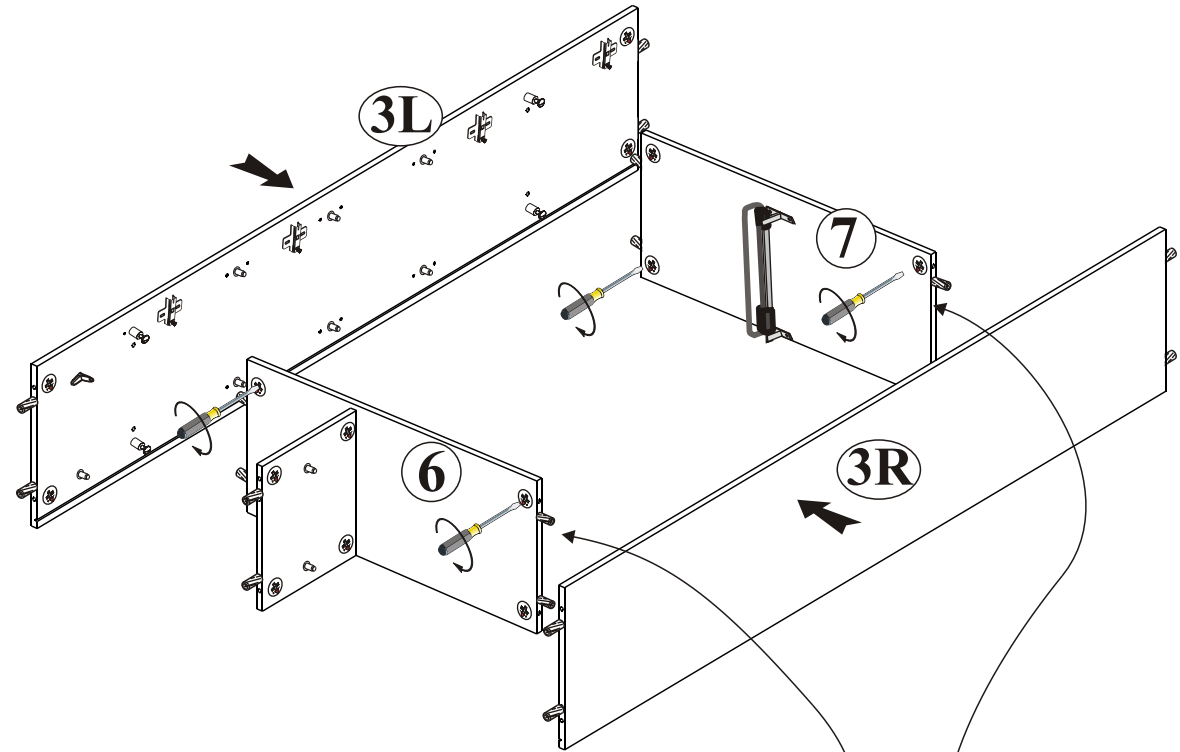

7

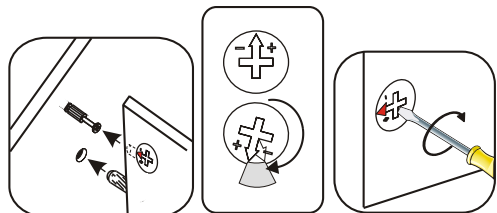
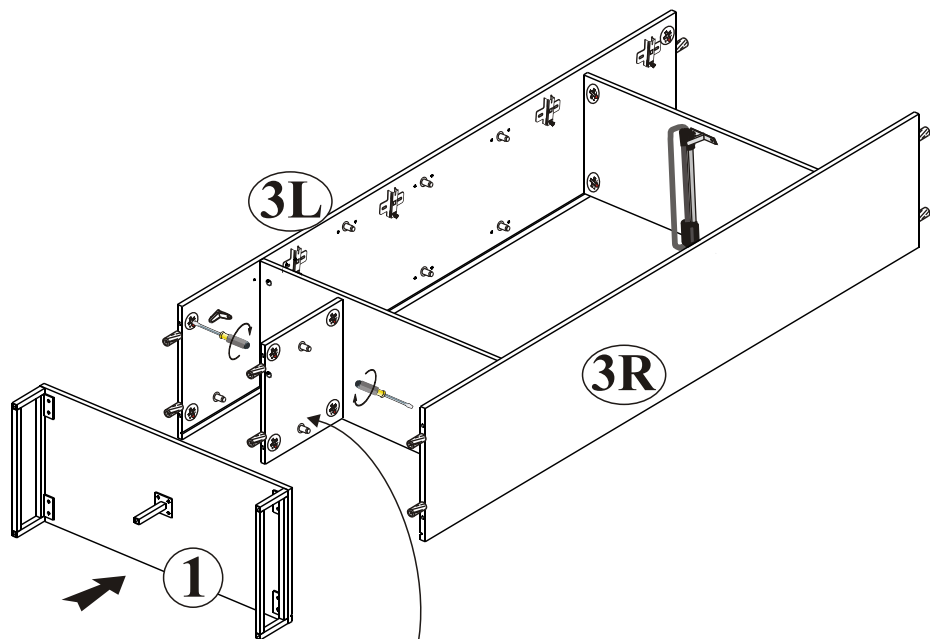

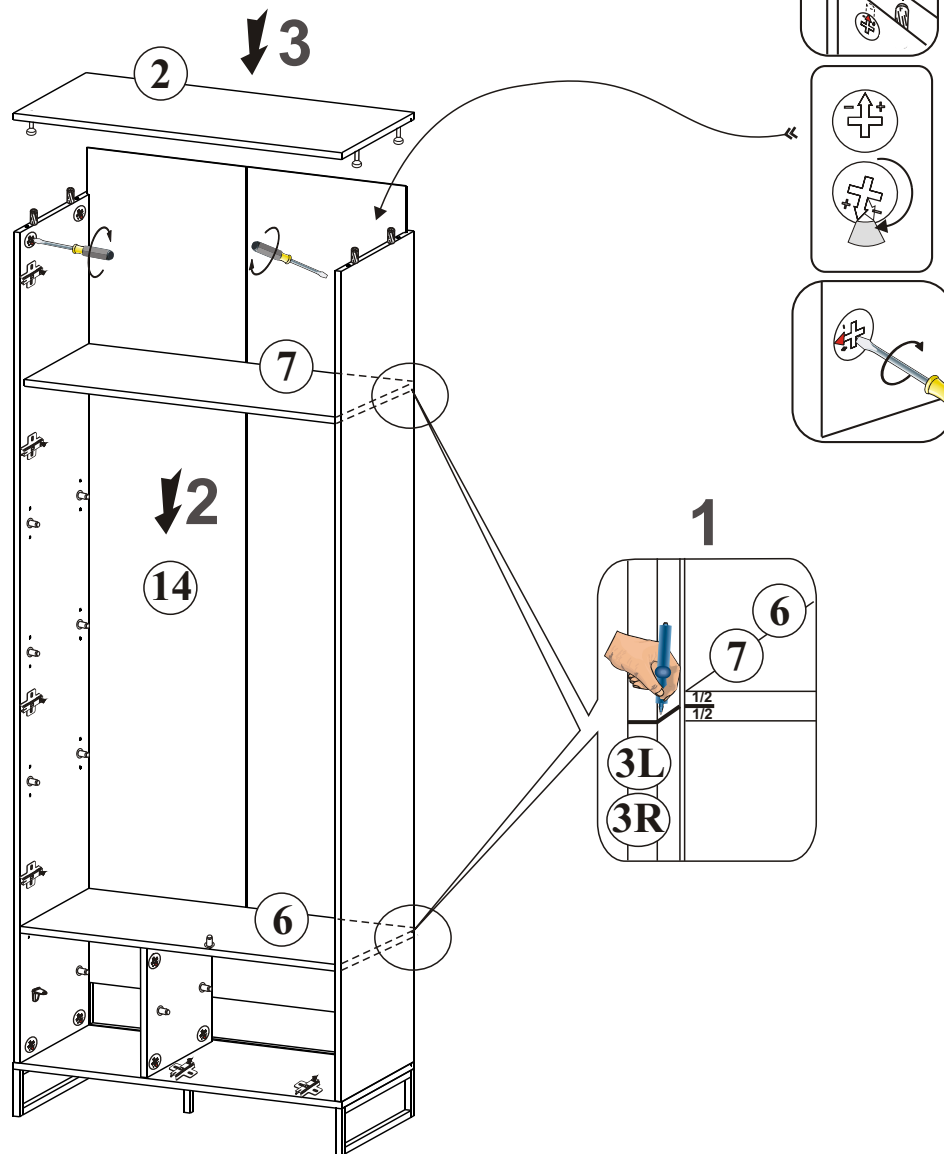

8



9

A=B 😊 ✓

- (S6)  3x20 x4
- (J23)  x18

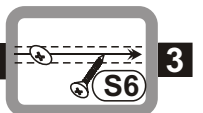
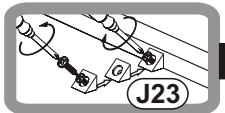
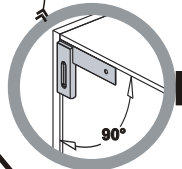
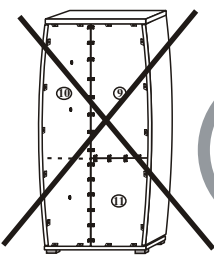
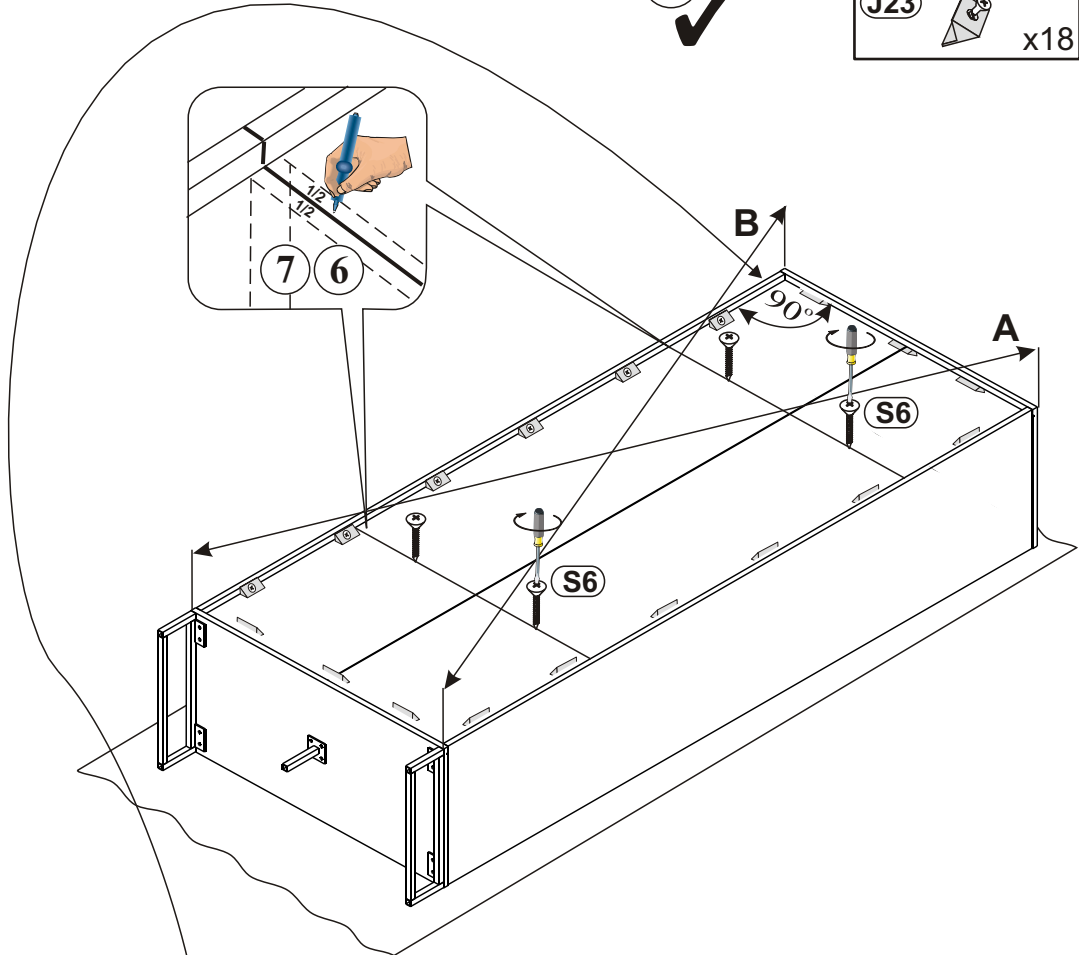

10

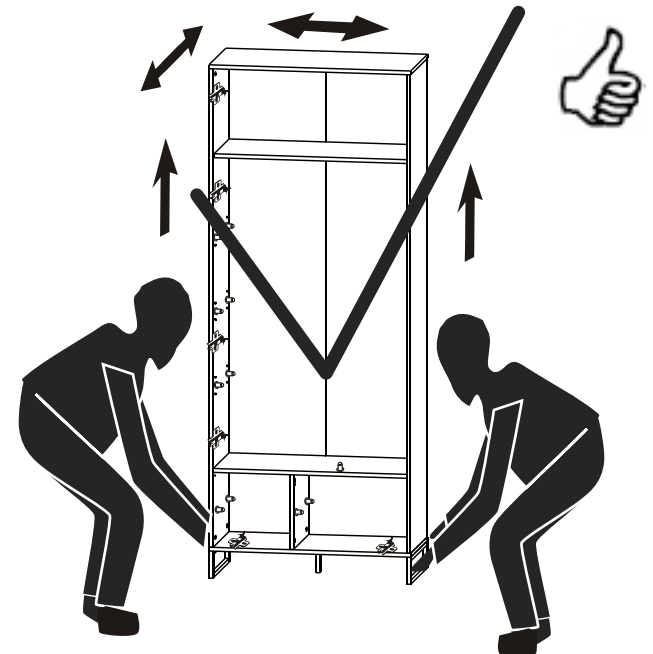
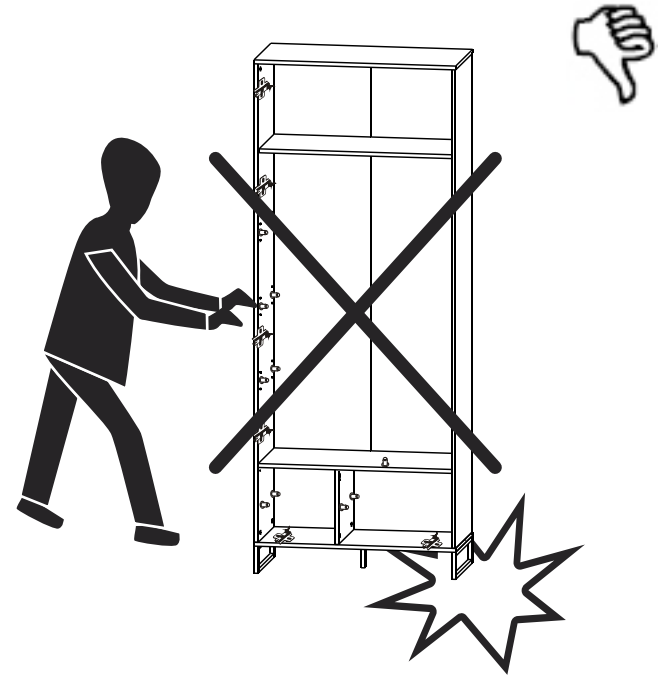

ROOF

30C1--01

11

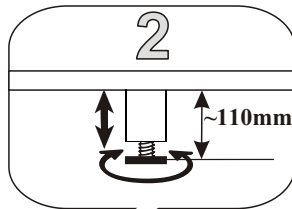
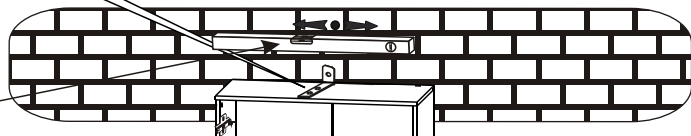
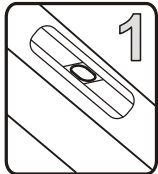
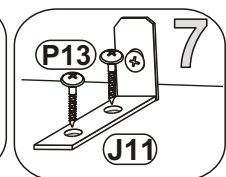
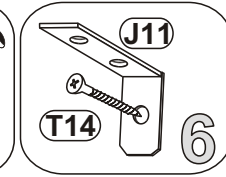
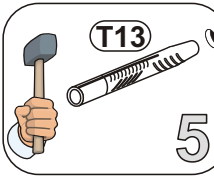
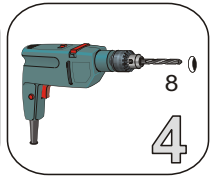
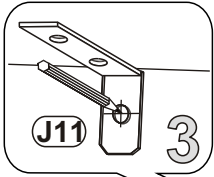
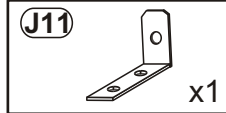
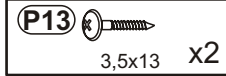

16

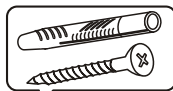
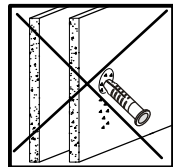
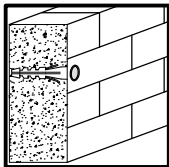
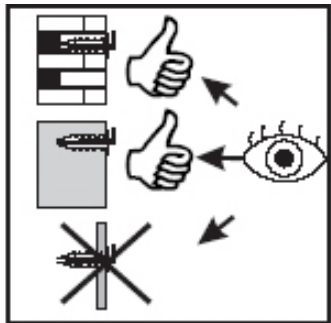

12

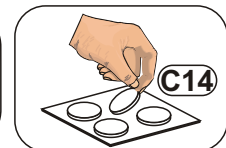
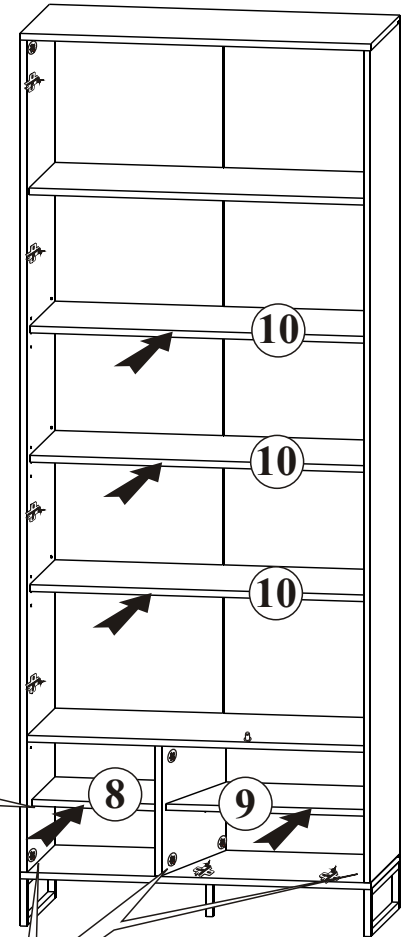
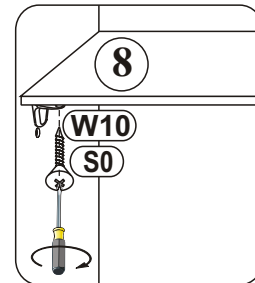
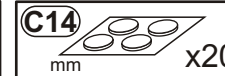

13

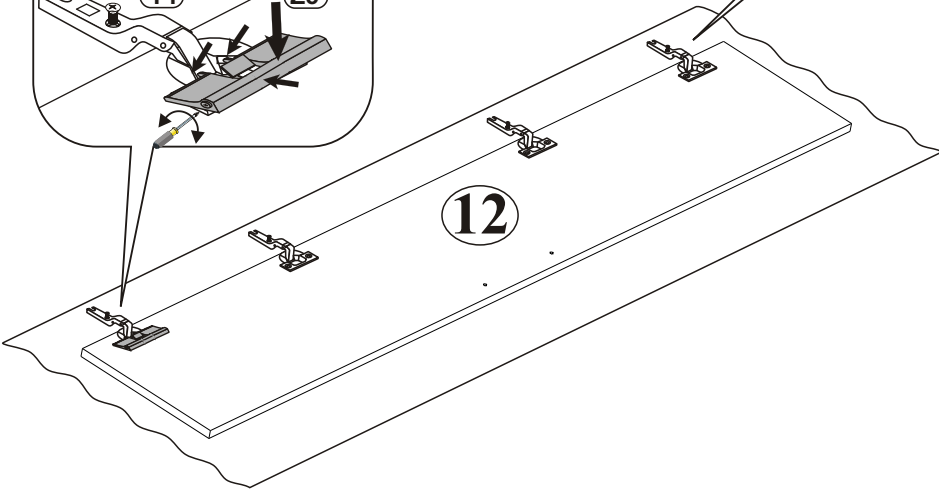
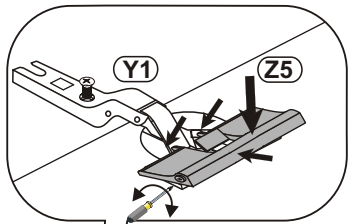
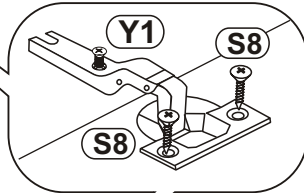
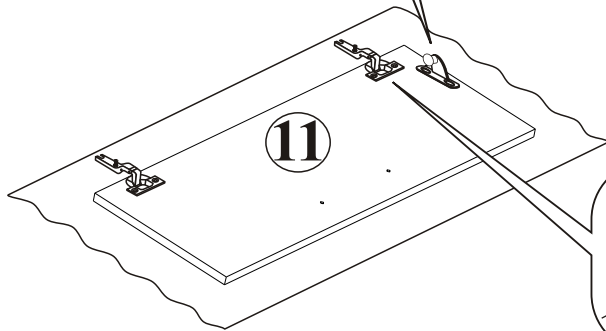
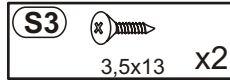
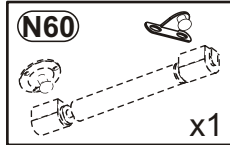
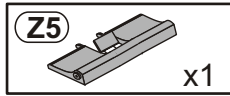
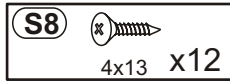
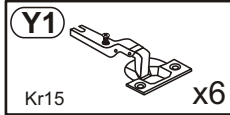
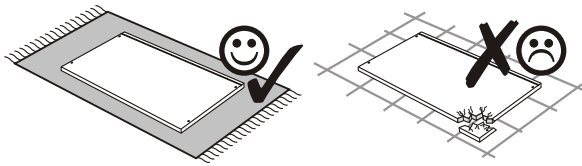

14

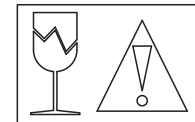
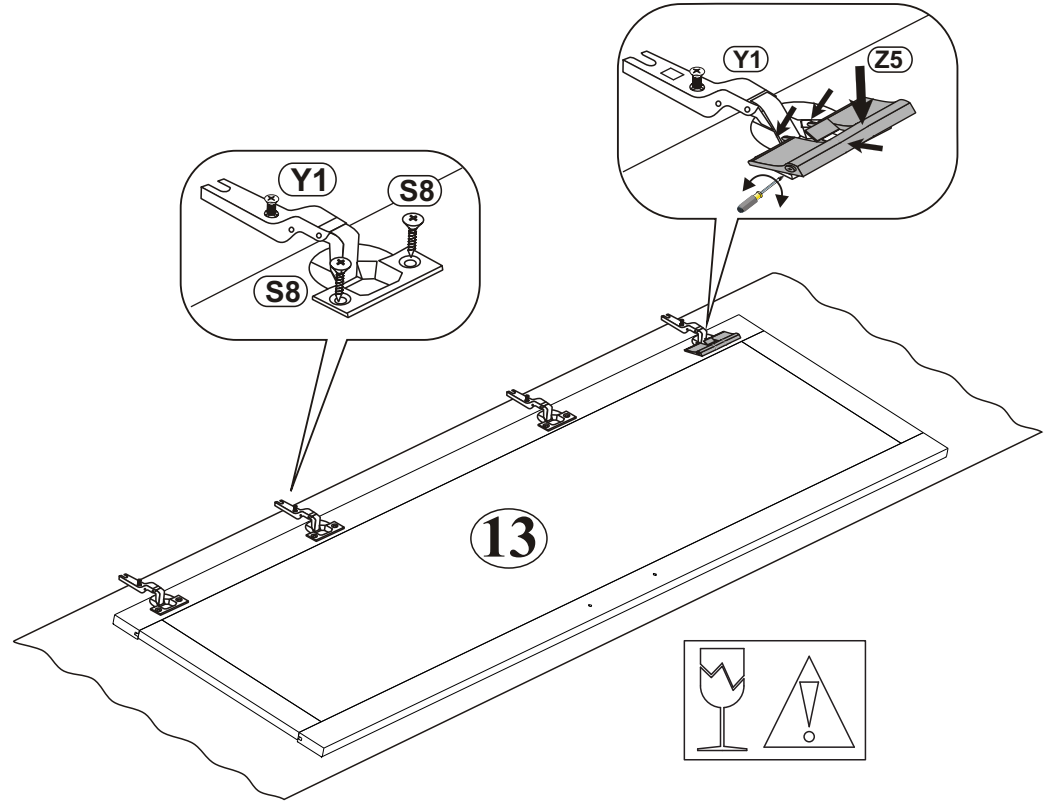
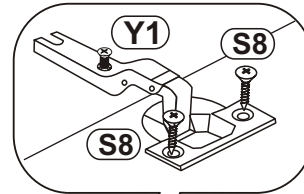
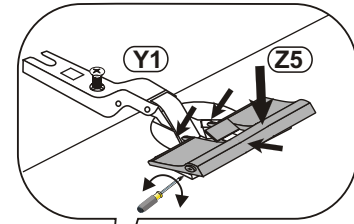
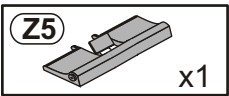
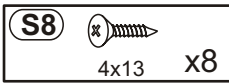
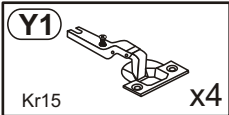
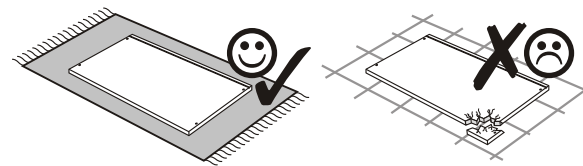

15

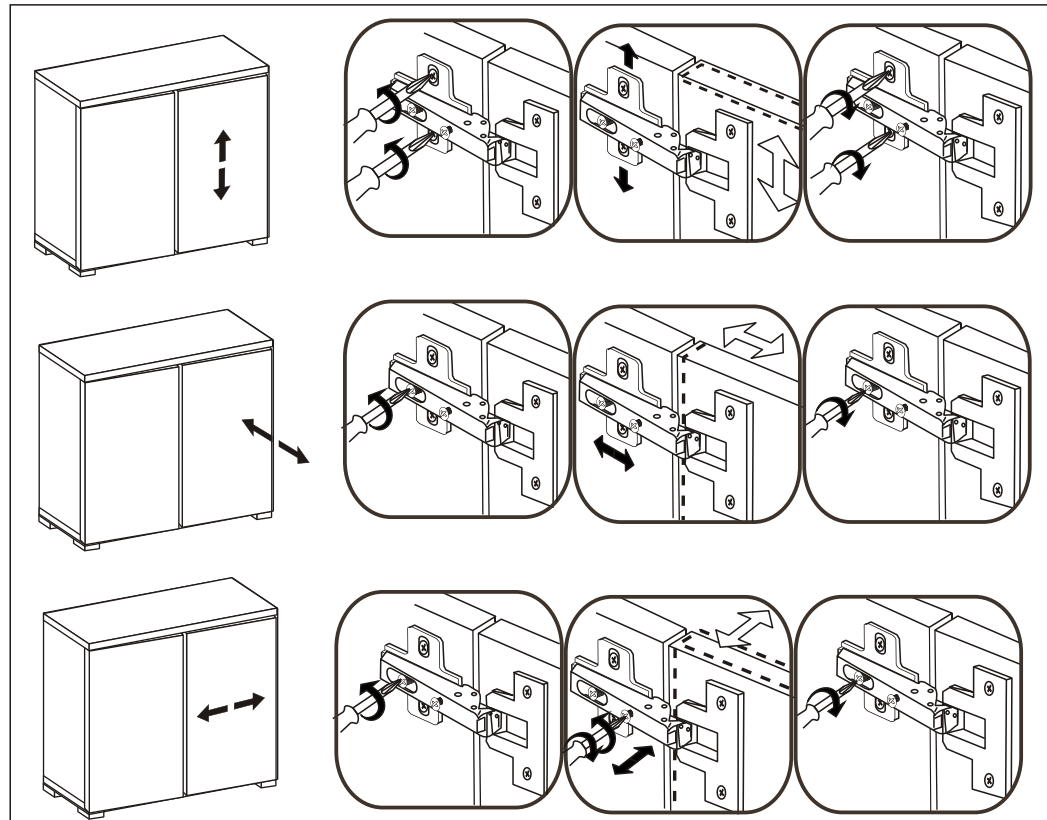
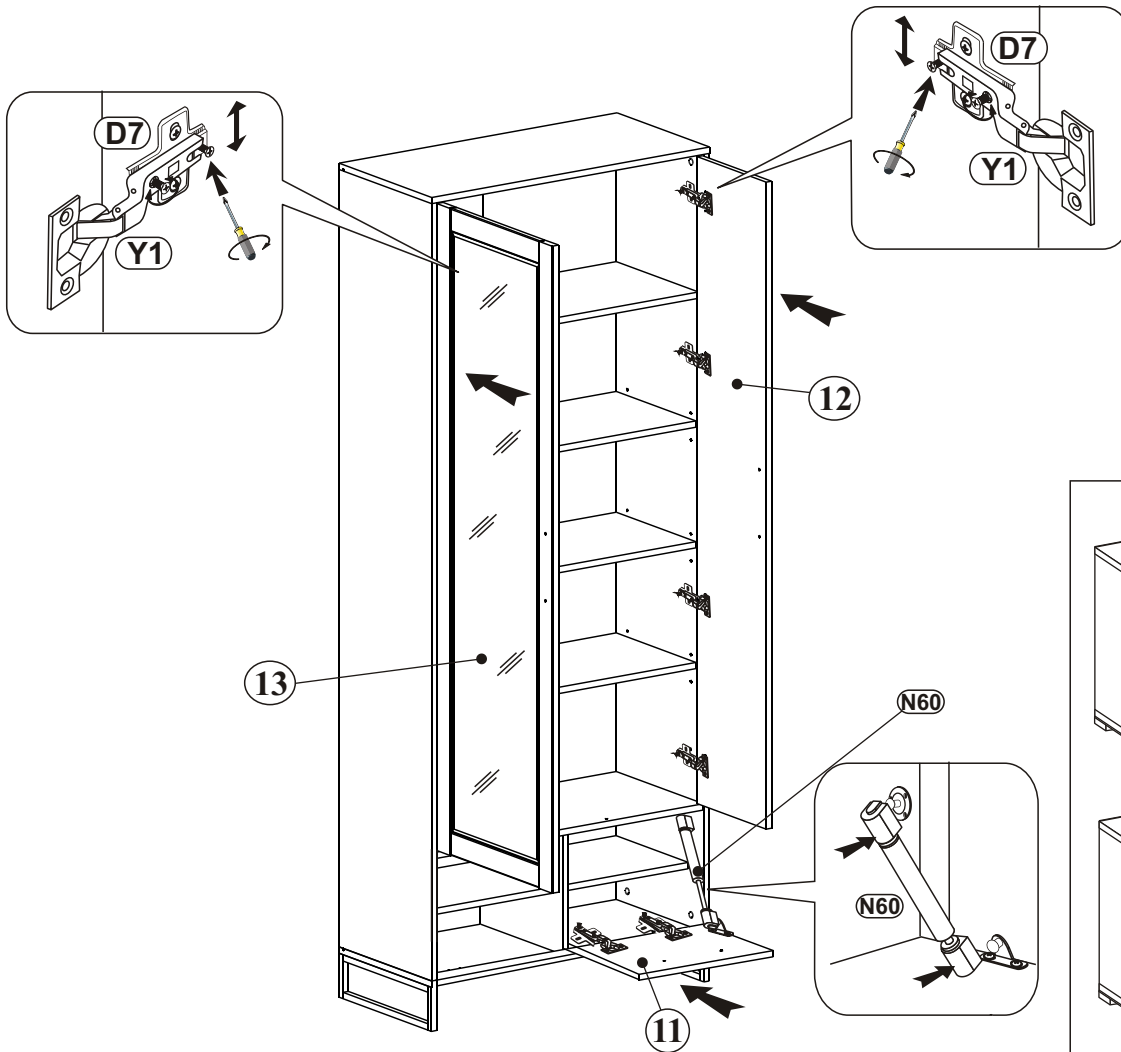
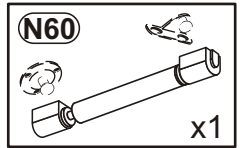

16

U160  x3

A14  M4x22 x6

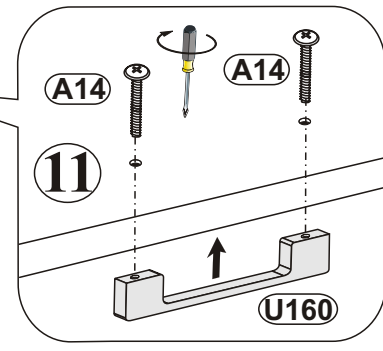
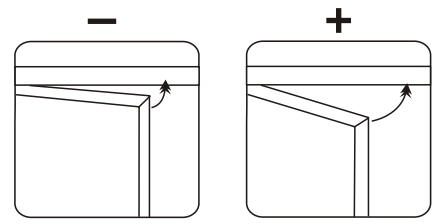
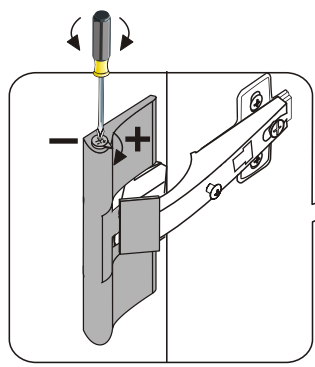
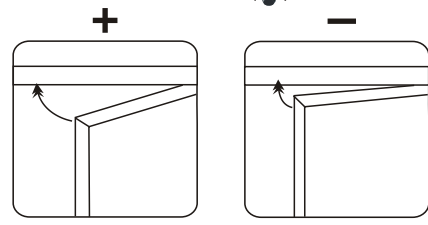
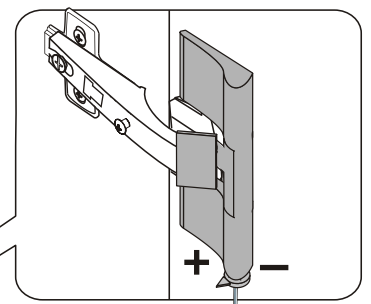
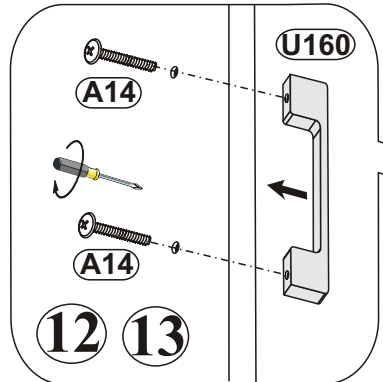
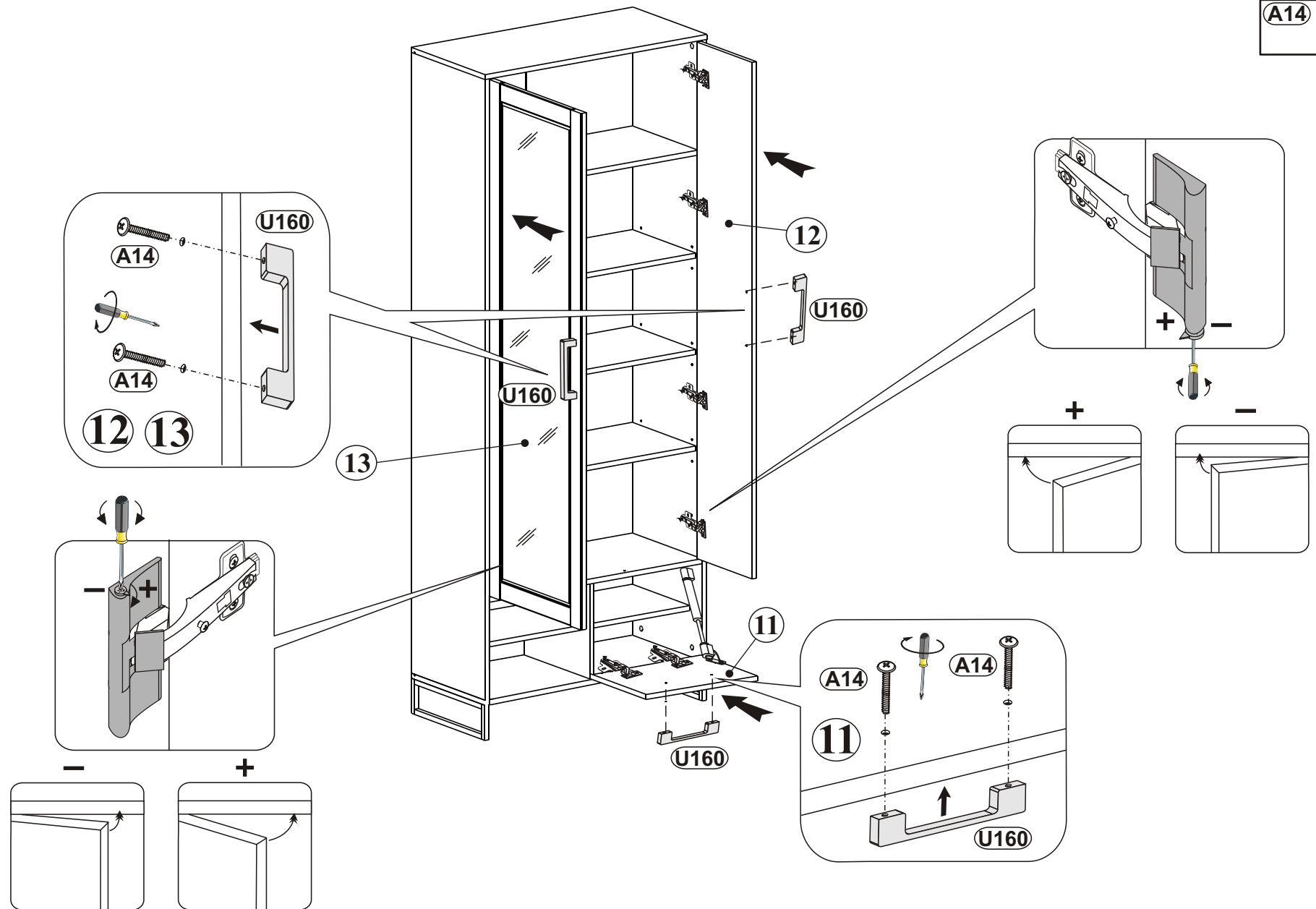

ROOF

30C1--01

80

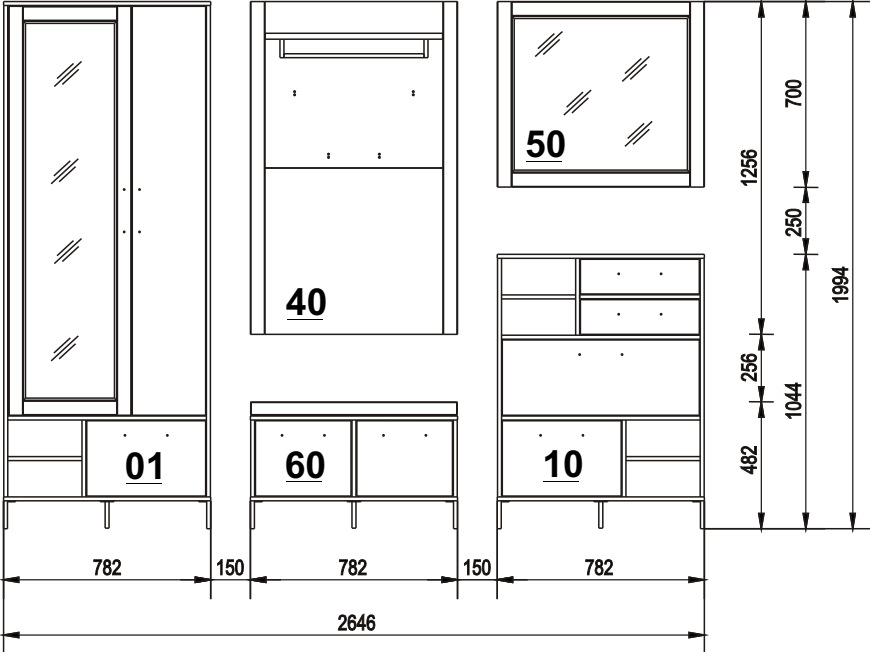

81

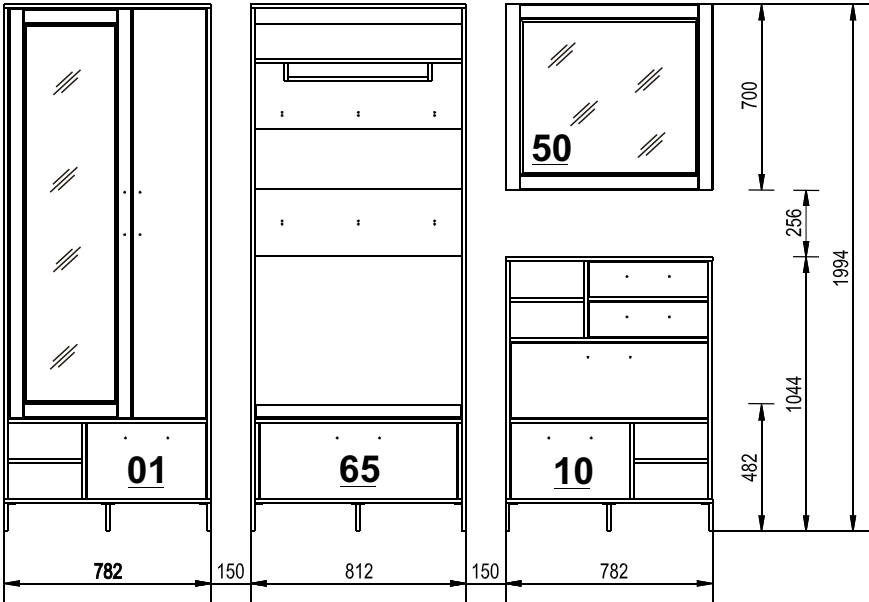

D CH AT LI LU Kleintelle und Verpackungsfolien bei der Möbelmontage von Kindern fernhalten!
GB US Keep small parts and plastic film out of the reach of children!
FR BE NC Tenir les petites pièces et les films plastiques hors de la portée des enfants!
NL Houd de kleine onderdelen en de plastic folie uit de buurt van kinderen!
IT Tenere i componenti di piccole dimensioni e le pellicole di plastica fuori dalla portata dei bambini!
SI Maljnih delov in embalažnih folije pri montaži pohištva hranite izven dosega otrok!
XS HR BA Male dijelove i foliju za pakovanje držite pri montaži pohištva napještaja držite dalje od djece
HU Bitorzszerelés közben a kis alkatrészek és a csomagoló fóliák gyermekékhöz távol tartandók!
BG Дребни детайли и опаковъчни фолия да се държат далеч от деца при монтажа на мебелите!
CZ SK Vid montáži nábytku uchovávejte drobné díly a obalové fólie z dosahu dětí!
SE Vid möbelformering ska smådelar och förpackningsfolien hållas oåtkomliga för barn!
RO Tineți departe de copii piesele mici și folia de ambalat la montarea mobiliei!
ES ¡Durante el montaje, mantenga alejados de los niños las piezas pequeñas y el material plástico de embalaje!

D CH AT LI LU Möbelmontage muss auf ebenerm Untergrund erfolgen. Bei Wandmontagen immer geeignetes Befestigungsmaterial verwenden.
GB US Furniture must be assembled on a flat surface. For assembly to the wall only use suitable fixing materials.
FR BE NC Le meuble doit être monté sur une surface plane. Pour le montage mural, utilisez des accessoires de fixation adaptés au type de mur.
NL De meubels dienen op een vlakke ondergrond te worden gemonteerd. Voor wandmontage moeten geschikte bevestigingsmaterialen worden gebruikt.
IT Il montaggio dei mobili deve avvenire su un fondo piano. Per il montaggio si prega di utilizzare solo materiali adatti.
SI Pohištvo je treba montirati na ravni podlagi. Pri stenski montaži vedno uporabite pritriljveni material.
XS HR BA Namještaj se mora montirati na ravnoj podlozi. Kod montaže na zid uvijek koristite prikladan materijal za pričvršćivanje.
HU A bútor szerelését silk felületen kell végezni. Falra szereléshez mindig megfelelő rögzítianyagot kell használni.
BG Монтажът на мебелите да се извършва на равна основа. При стънен монтаж винаги да се използва подходящ крепежен материал.
CZ SK Montáž nábytku provádějte na rovinném podkladu. Při montáži na stěnu používejte vždy vhodný příslušovací materiál.
SE Montering av möbeln måste göras på jämnt underlag. Vid väggmontering ska lämpligt uppfästingsmaterial användas.
RO Montarea mobiliei trebuie să se realizeze pe o pardoseală dreaptă. La montarea la perete utilizați întotdeauna material de fixare adecvat.
ES El montaje debe efectuarse sobre una superficie uniforme. En el montaje mural emplee siempre el material de fijación adecuado.

D CH AT LI LU Bitte beachten Sie die Montageanleitung. Halten Sie immer die angegebene Wattzahl ein. Verhindern Sie einen Hitzestau.
GB US Please observe the assembly instructions. Do not exceed the max. given wattage. Ensure that the heat is not allowed to build up.
FR BE NC Veuillez respecter la notice de montage. Respectez impérativement le nombre des watts maximal. Veillez à éviter toute accumulation de chaleur.
NL Lees a.u.b. de montagehandleiding door. Houd u bezigst aan het max. opgegeven wattage. Zorg ervoor dat geen hittestuwijng onstaat.
IT Attenersi alle istruzioni di montaggio. Rispettarsi rigorosamente il numero di watt max. indicato. Assicurarsi che non si verifichi un accumulo di calore.
SI Upoštevajte navodila za montažo. Vedno upoštevajte navedeno število vatov. Preprečite zastoj vročine.
XS HR BA Obratite pažnju! Vas pozor na uputu za montažu. Uvijek se pridržavajte navedenog broja vati. Izbjegavajte zastoj vrućine.
HU Vegye figyelembe a szerelési útmutatót. Mindig tartsa be a megadott wattszámat. Akadályozza meg a hőelődést.
BG Моля, вземете под внимание ръководството за монтаж. Спазвайте винаги посочените ватове. Избягвайте акумулиране на топлина.
CZ SK Dodržujte prosím návod k montáži. Vždy dodržujte uvedenou hodnotu výkonu (watt). Zabraňte tak přehřívání.
SE Följ monteringsanvisningen. Följ alltid angivet wattal. Undvik att hetta uppstår.
RO Respectați instrucțiunile de montaj. Respectați întotdeauna numărul de watt impus. Evitați acumularea de căldură.
ES Le rogamos que tenga presente las instrucciones de montaje. Respete siempre el número indicado de vatios. Evite la acumulación de calor.

D CH AT LI LU Halten Sie die max. zulässigen Belastungswerte der Möbelteile ein. Details siehe Montageanleitung
GB US Comply with the max. permissible loads. For details, please refer to the assembly instructions
FR BE NC Respectez les valeurs de charge max. admissibles des parties de meubles. Pour plus de détails, cf. la notice de
NL Houd de maximaal geoorloofde belastingwaarden van de meubeldelen aan. Voor details verwijzen wij naar de montagehandleiding
IT Rispettare la portata max. permessa degli elementi del mobile. Per dettagli si vedano le istruzioni di montaggio e si vada
SI Upoštevajte največjo dovoljeno obremenitev delov pohištva. Podrobnosti najdete v navodilih za montažo in na
XS HR BA Tartsa be a bútor elemek max. megengedett terhelési értékét. A részleteket lásd a szerelési útmutatóban
HU Tartsa be a bútor elemek max. megengedett terhelési értékét. A részleteket lásd a szerelési útmutatóban
BG Спазвайте макс. допустимите стойности на натоварване на мебелите. За подробности виж ръководството за монтаж
CZ SK Dodržujte max. přípustné hodnoty zatížení nábytkových dílů. Podrobnosti viz návod k montáži
SE Följ max. tillåten belastning av möbeldelarna. Mer information finns i monteringsanvisningen
RO Respectați valorile de solicitare max. admise pentru corpurile de mobilier. Pentru detalii consultați instrucțiunile de montaj
ES Respete los valores máximos de carga admisibles para las piezas de los muebles. Consulte los detalles en las instrucciones

D CH AT LI LU Zur Möbelreinigung ein mit Wasser befeuchtetes, fusselfreies Baumwolltuch verwenden. Geeignigte Flächen immer trockenreiben!
GB US To clean the furniture only use a water dampened lint-free cotton cloth. Once cleaned, always wipe the surfaces dry.
FR BE NC Utilisez un chiffon en coton non pelucheux humidifié avec de l'eau pour nettoyer les meubles. Séchez systématiquement les surfaces
NL nettooyes en les frottant!
IT Gebruik een met water bevochtigde, pluïsvrije katoenen doek om de meubels te reinigen. Wrijf gereinigde oppervlakken altijd droog!
SI Per pulire il mobile utilizzare un panno di cotone inumidito d'acqua e che non perde pelucchi. Asciugare sempre le superfici che si sono
XS HR BA puštile!
HU Za čišćenje pohištva uporabljajte vlažno bombažno krpo. Ki ne pušča vlaken. Očiščene površine vedno obrišite do suhlega!
BG За чистиенje namještaja koristite sa vodom navlaženu pamučnu krpu koja ne ispušta vlakna. Očišćene površine uvijek obrišite suhom krpom!
CZ SK Bůtortzátáshoz vízzel benedvesített, nem szárlázódó pamukkenőt használjon. A megtisztított felületeket mindig törölje szárazra!
HU For mbelrengőbning används en luddfri bomullsduk fuktad med vatten. Rengjörda ytor ska alltid torikas torra!
SE Pentru curățarea mobiliei utilizați o lavetă din bumbac fără scame umezită cu apă. Suprafețele curățate se șterg întotdeauna până se usucă!
RO Emplae un paño de algodón humedecido con agua y libre de pelusa para la limpieza de los muebles. ¡Seque siempre las superficies que ha limpiado!